

Area		JAPAN	EUROPE	EUROPE DERIVATIVE 1
Model Name		XRJ-50X90K	XR-50X90S	XR-50X92K
SV No.		SV-40365	SV-40321	SV-40323
DIMENSION	TV only (W x H x D)	111.9 x 64.9 x 7.0 cm	Approx. 111.9 x 64.9 x 7.0 cm	Approx. 111.9 x 64.9 x 7.0 cm
	TV only with camera (WxHxD)	-	-	-
	TV with Stand (Standard position) (W x H x D)	111.9 x 71.5 x 28.6 cm	Approx. 111.9 x 71.5 x 28.6 cm	Approx. 111.9 x 71.6 x 30.3 cm
	TV with Stand (Narrow position) (W x H x D)	-	-	-
	TV with Stand (Soundbar position) (W x H x D)	-	-	-
	TV with Stand (Front position style) (W x H x D)	-	-	-
	TV with Stand (Back position style) (W x H x D)	-	-	-
	TV with Floor Stand (W x H x D)	-	-	-
	Stand Width (Standard position)	66.5 cm	Approx. 66.5 cm	Approx. 63.1 cm
	Stand Width (Narrow position)	-	-	-
	Stand Width (Soundbar position)	-	-	-
	Stand Width (Front position style)	-	-	-
	Stand Width (Back position style)	-	-	-
	Floor Stand Width	-	-	-
	VESA Hole Pitch	20.0 x 20.0 cm	20.0 x 20.0 cm	20.0 x 20.0 cm
WEIGHT	TV Only	13.5 kg	Approx. 13.5 kg	Approx. 13.5 kg
	TV with Stand (Standard position)	14.1 kg	Approx. 14.1 kg	Approx. 16.5 kg
	TV with Stand (Narrow position)	-	-	-
	TV with Stand (Soundbar position)	-	-	-
	TV with Stand (Front/Back position style)	-	-	-
	TV with Floor Stand	-	-	-
	Floor Stand weight (Supply)	-	-	-
	W-M't Br. Weight (Supply)	-	-	-
Remarks		MAIN STAND	MAIN STAND	CENTER STAND

WITH STAND

MAIN STAND
STANDARD POSITION

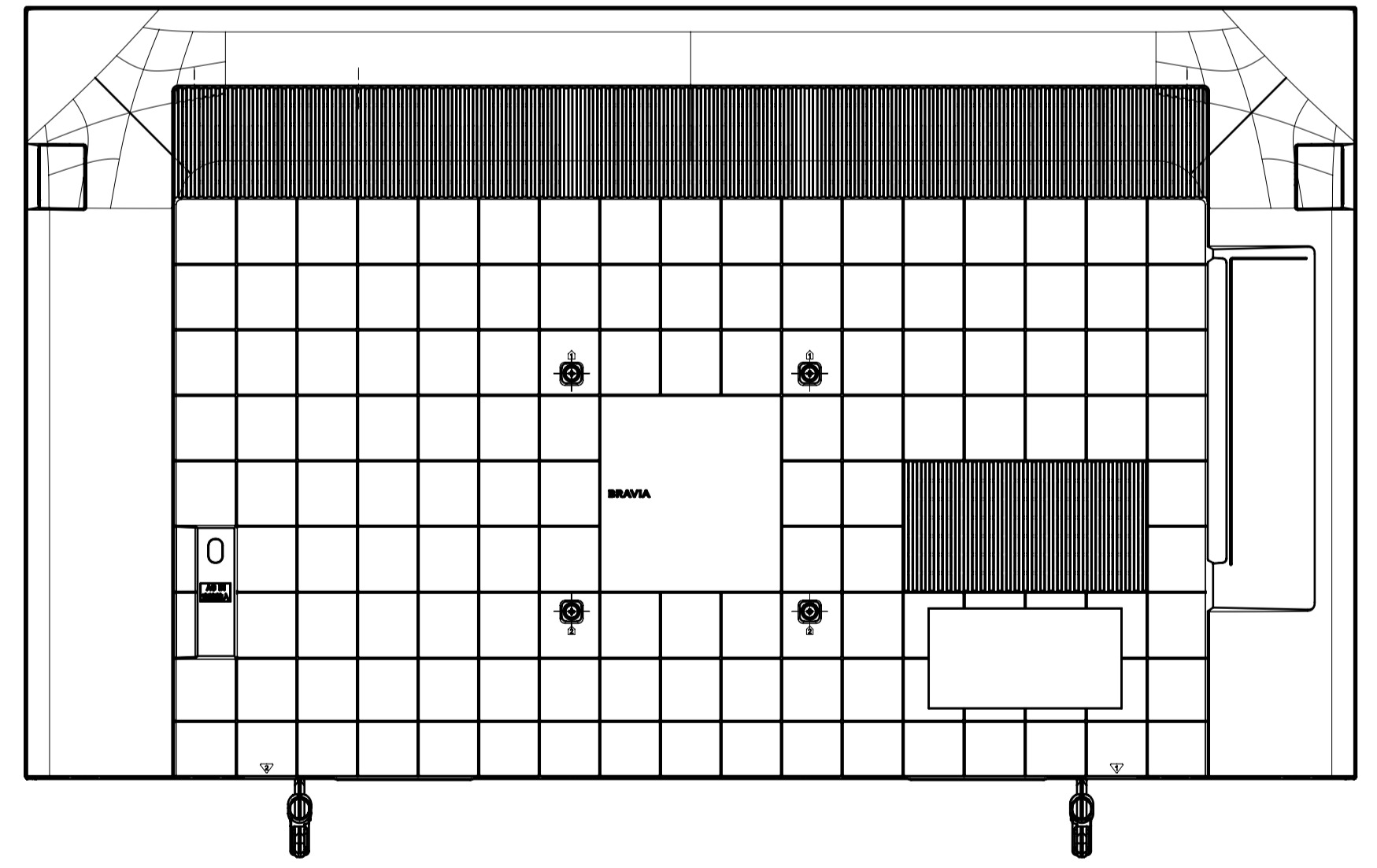
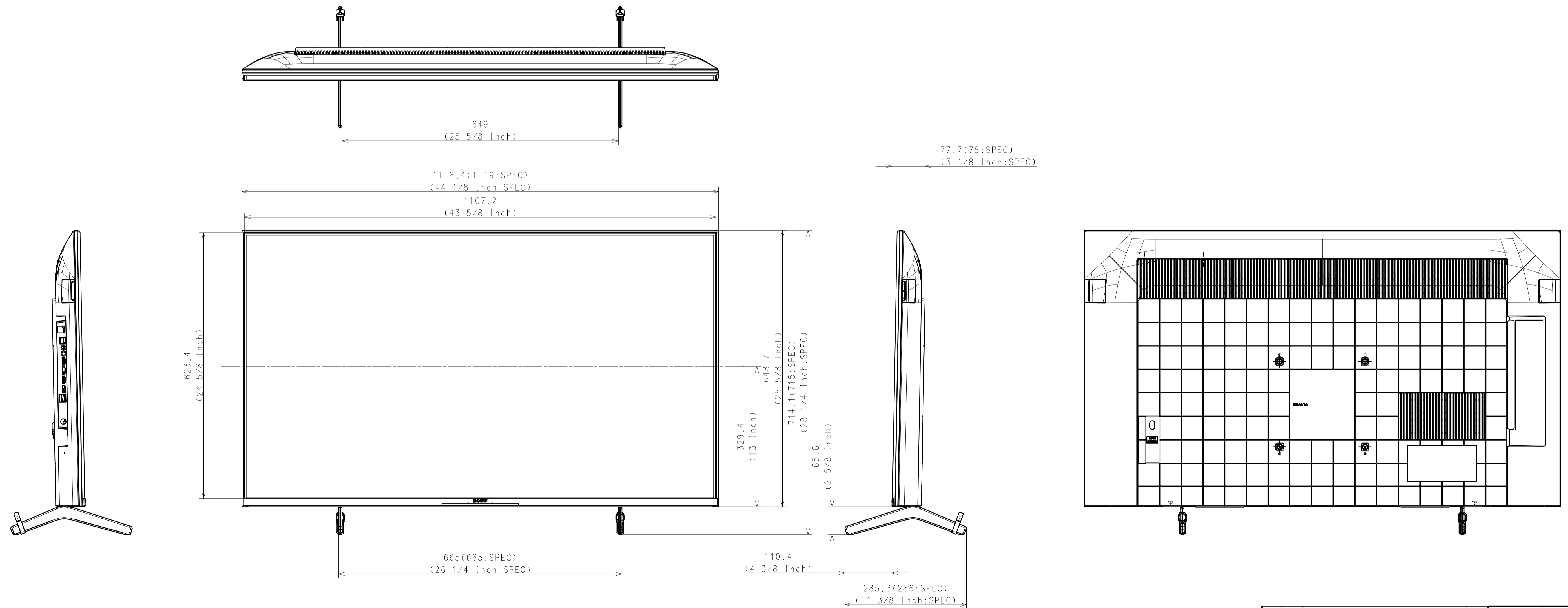

DATE OF ISSUE	2021.11.10
DOCUMENT TYPE	ASSEMBLY
TECHNICAL DRAWING	(JIS & ISO/IEC JIS)
GENERAL TOLERANCE	
MATERIAL COLOR	
FINISH COLOR	
RESPONSIBLE DEPARTMENT	50(X90S) EXTERIOR VIEW
PLANNED BY	50(X90S) EXTERIOR VIEW
DESIGNED BY	
CHECKED BY	
APPROVED BY	
SCALE	1:5
TENTATIVE MODEL	
SIZE	A1
UNIT	mm
PAGE NO.	1 / 4
SUFFIX	
REV. NO.	
SHEET/PAGES	

WITH STAND

CENTER STAND
STANDARD POSITION
(EUROPE DERIVATIVE 1 only)

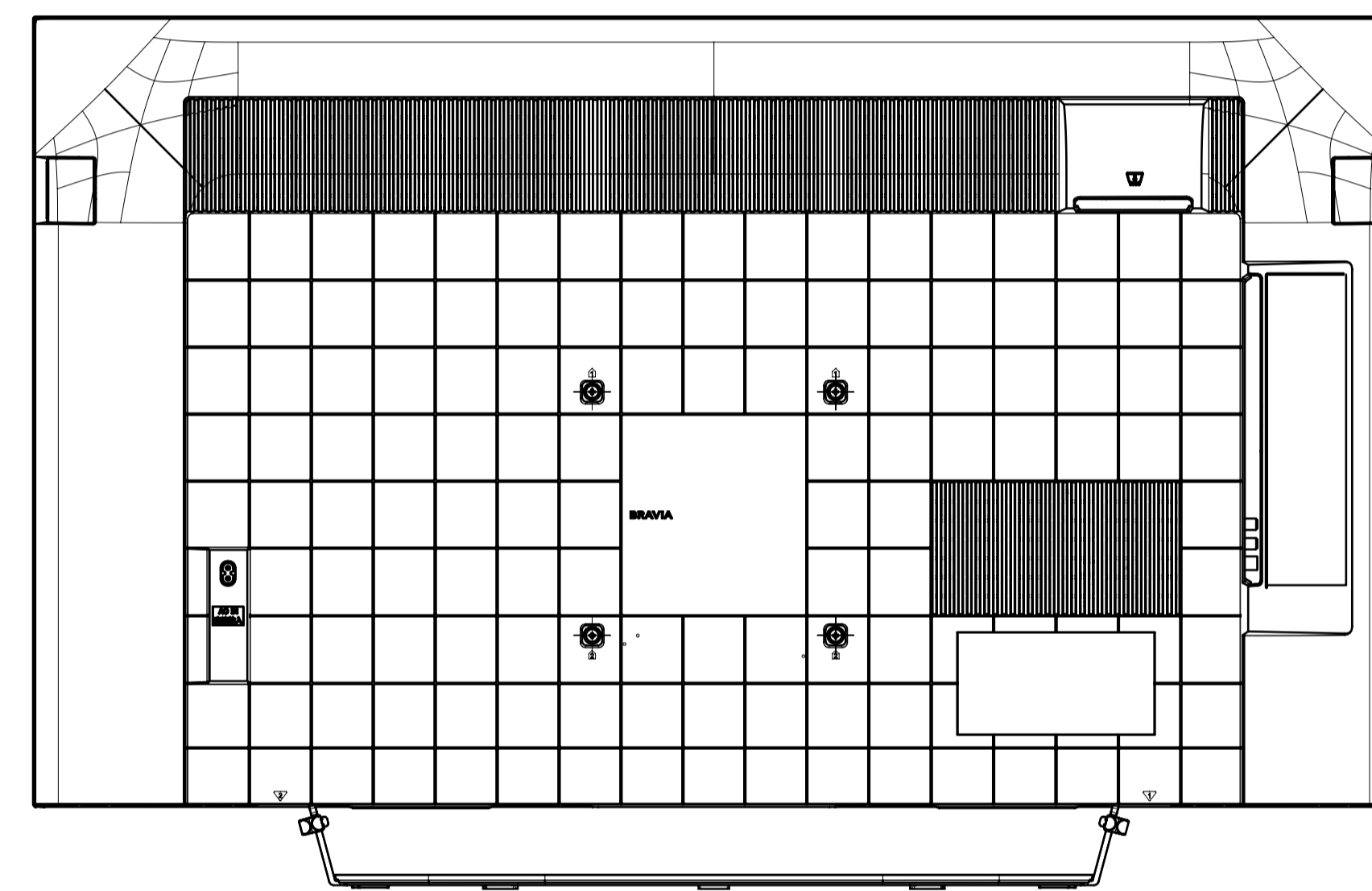
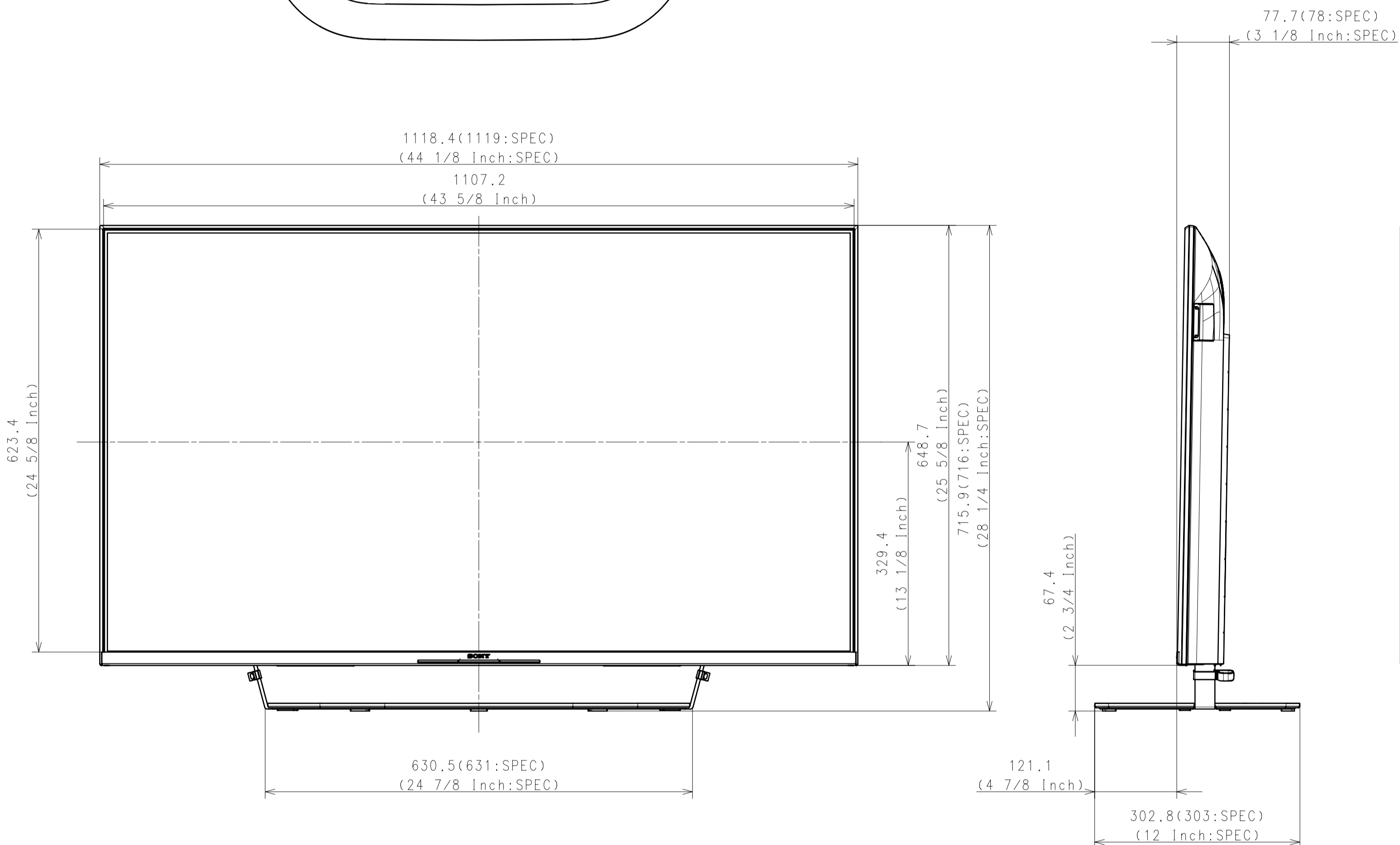
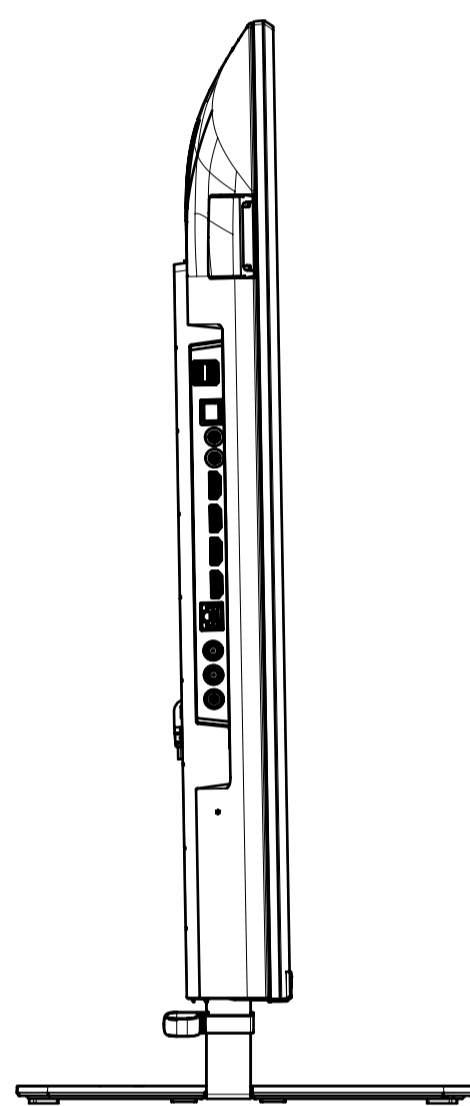
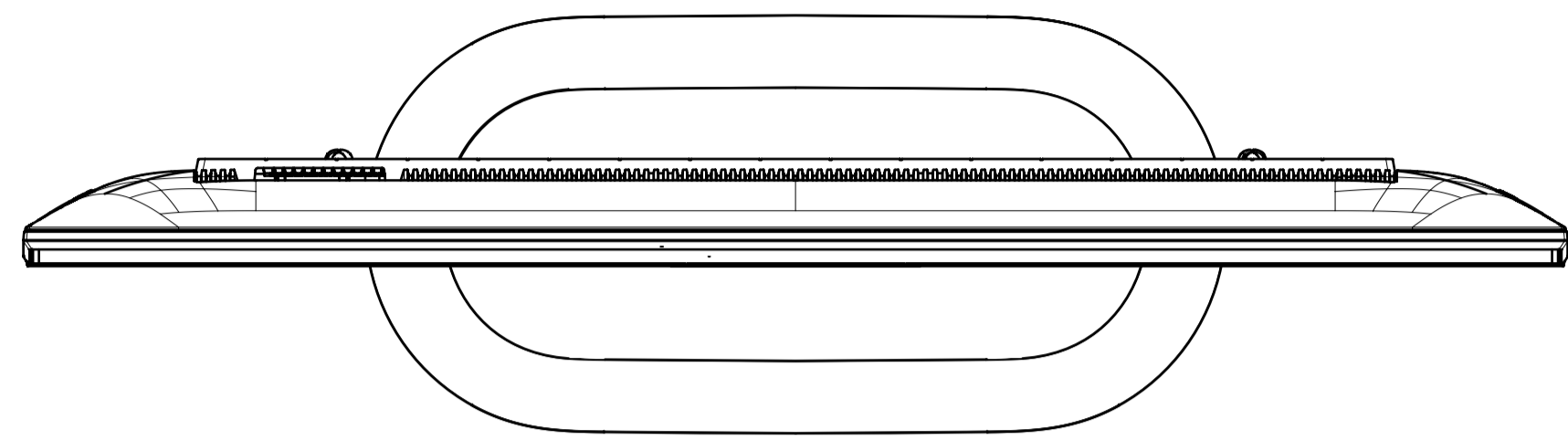

DESCRIPTION 1	LEGAL OWNER	SCALE
50(X90S) EXTERIOR VIEW	Sony Corporation	1:5
DESCRIPTION 2	PART NO.	SHEET/PAGES
50(X90S) EXTERIOR VIEW		2 / 4

WITHOUT STAND

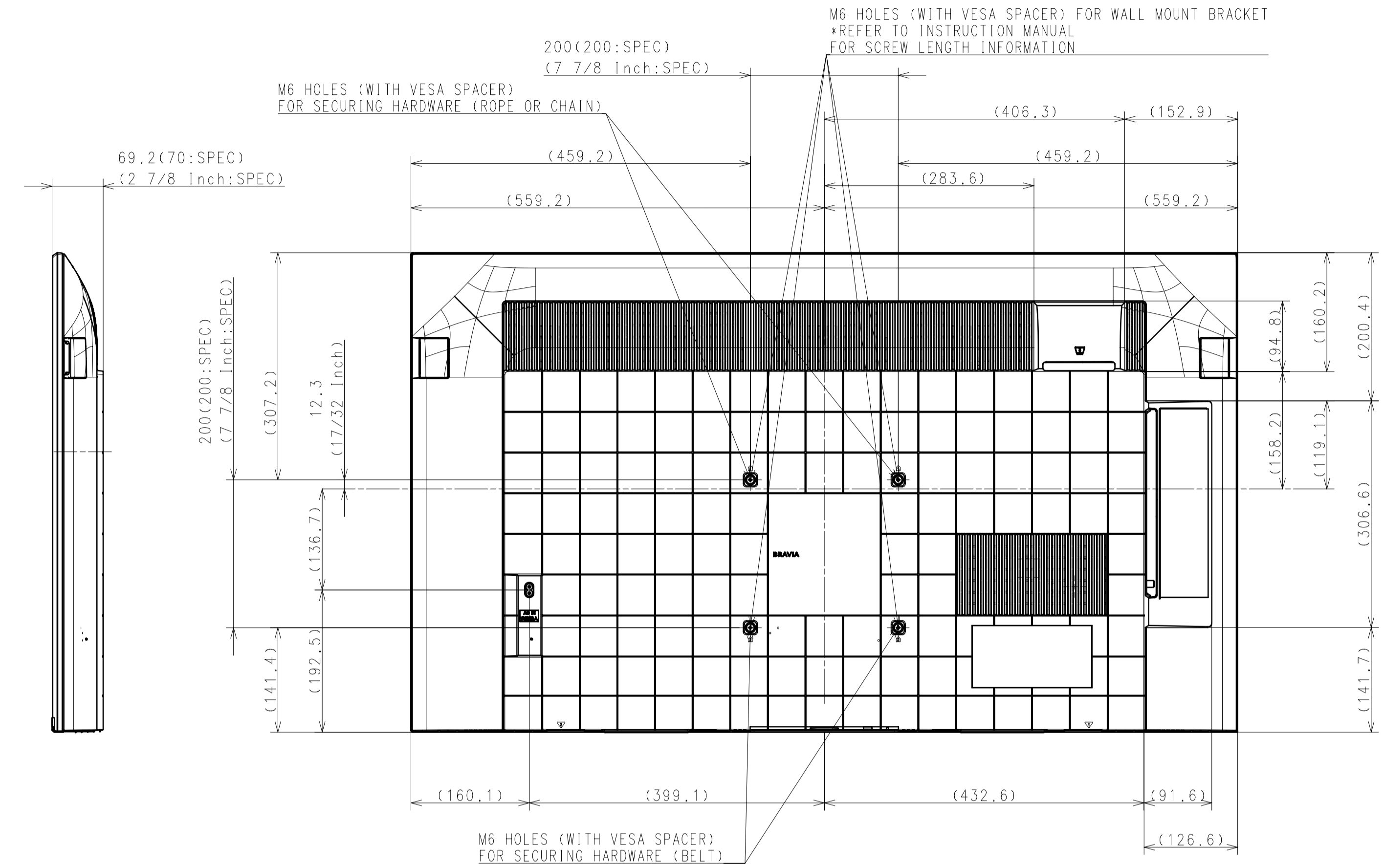
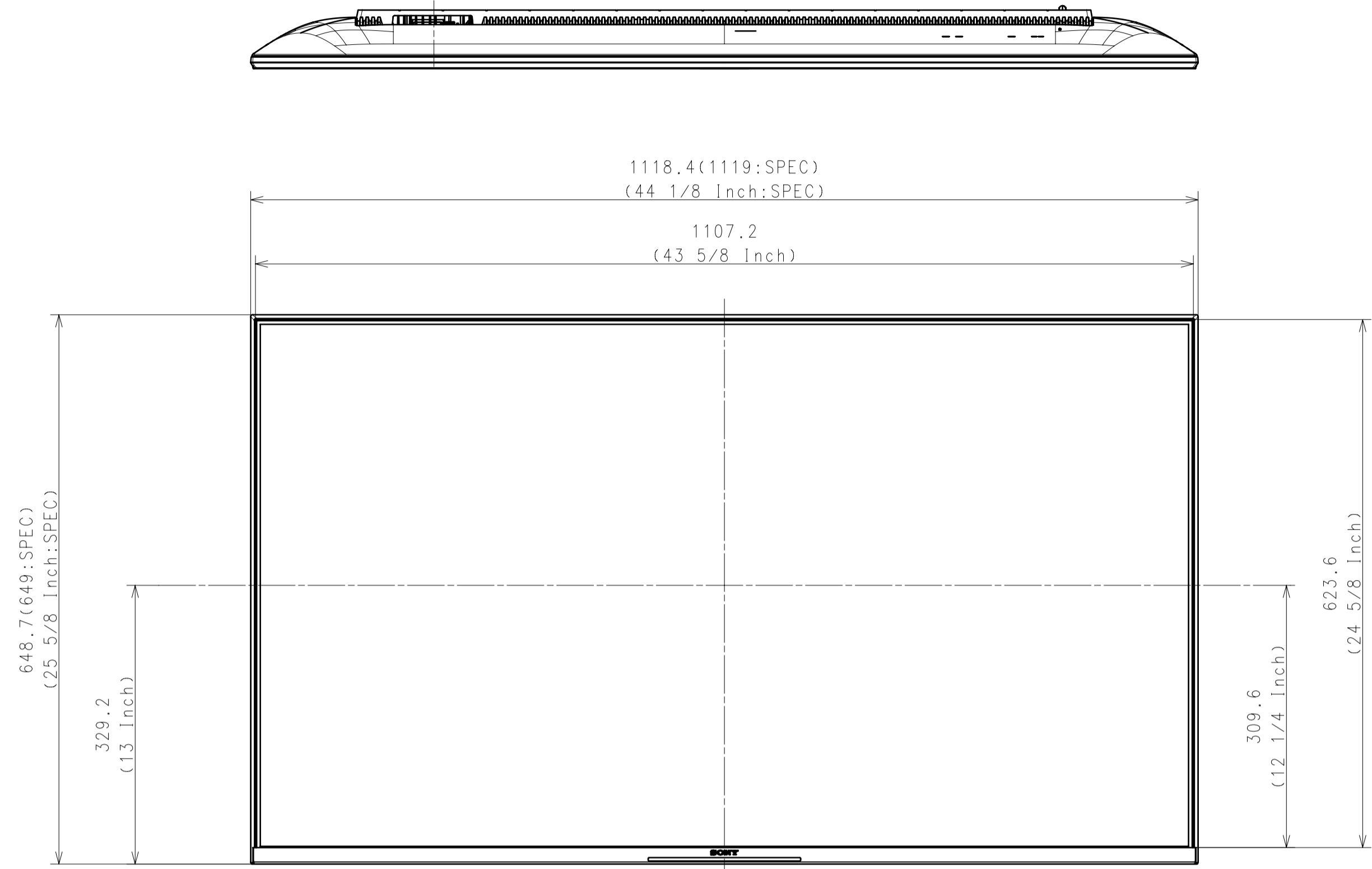

For EUROPE

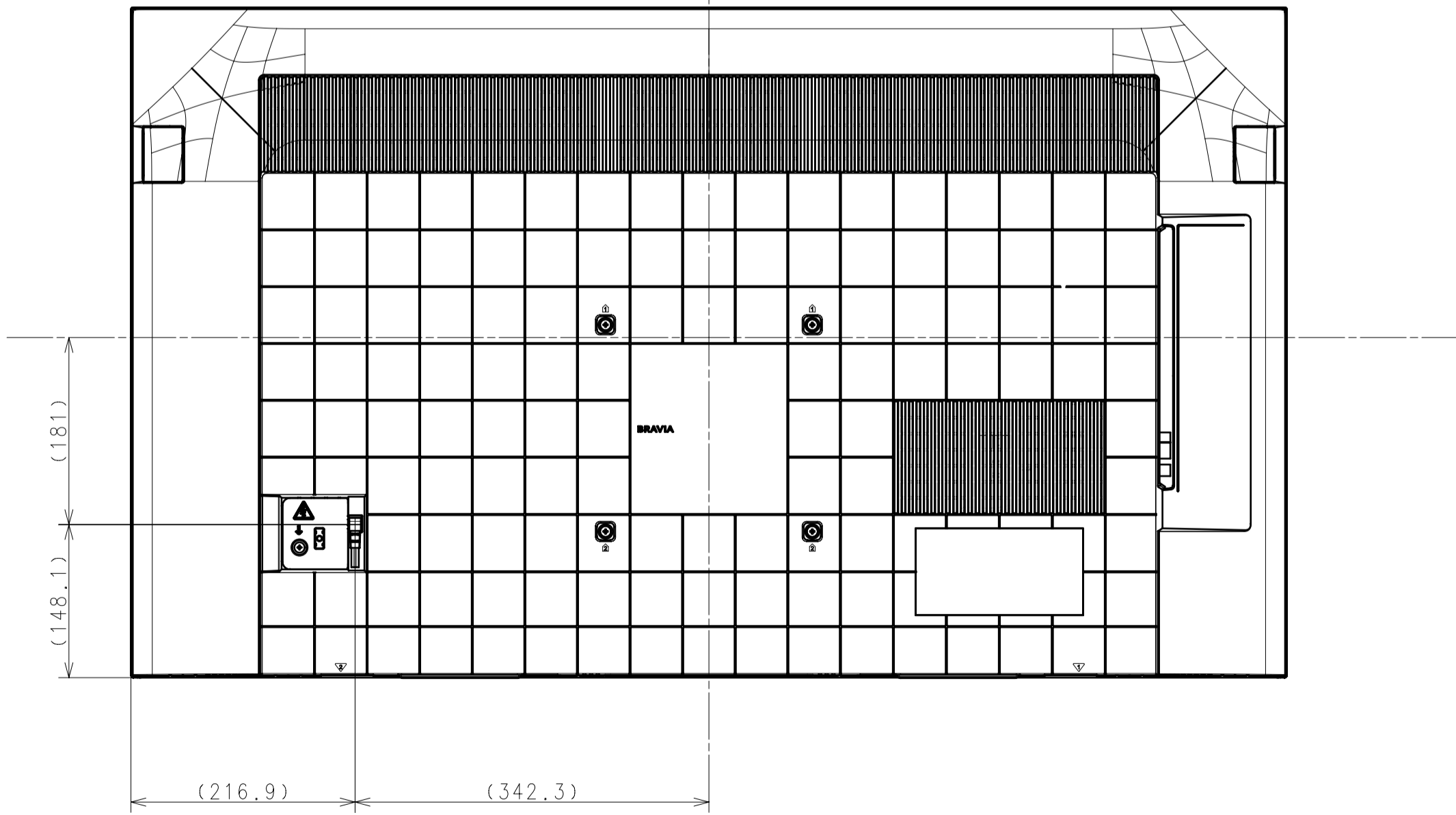

For JAPAN

DESCRIPTION 1	LEGAL OWNER	SCALE
50(X90S) EXTERIOR VIEW	Sony Corporation	1:5
DESCRIPTION 2	PART NO.	SHEET/PAGES
50(X90S) EXTERIOR VIEW		3 / 4

SU-WL450

STANDARD

SLIM

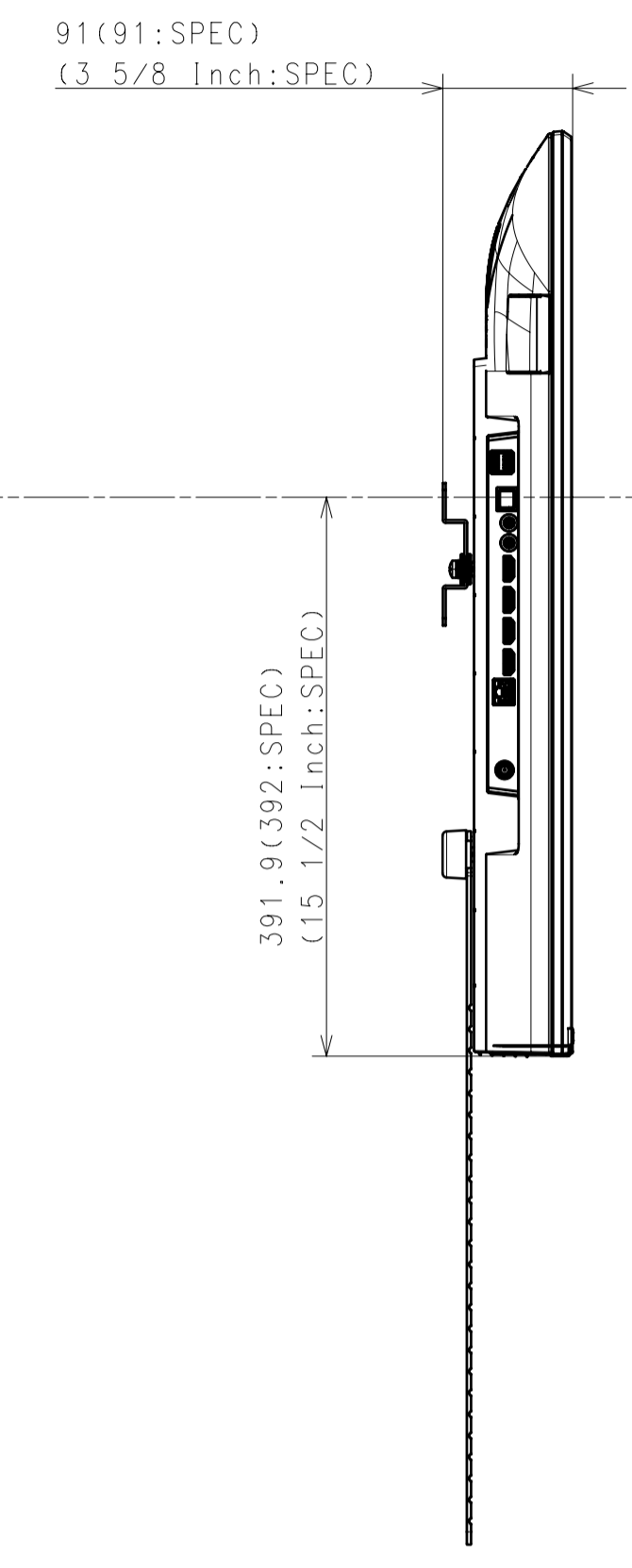
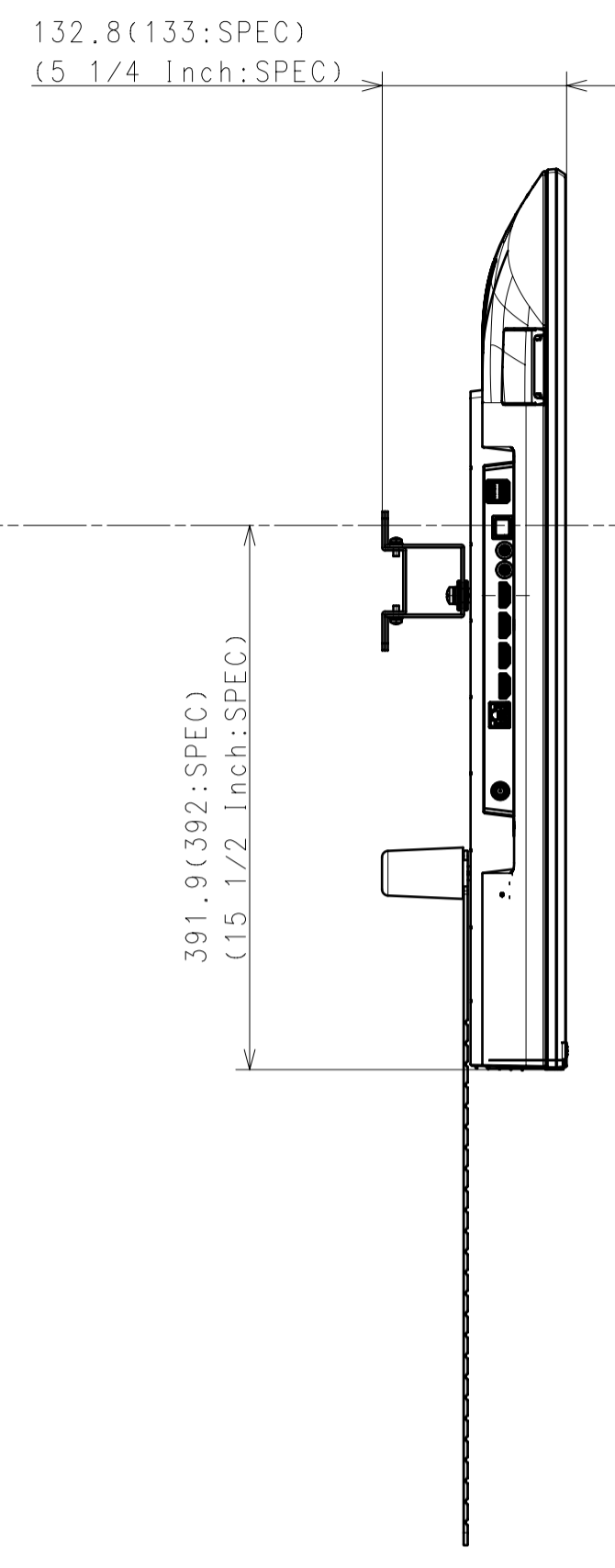
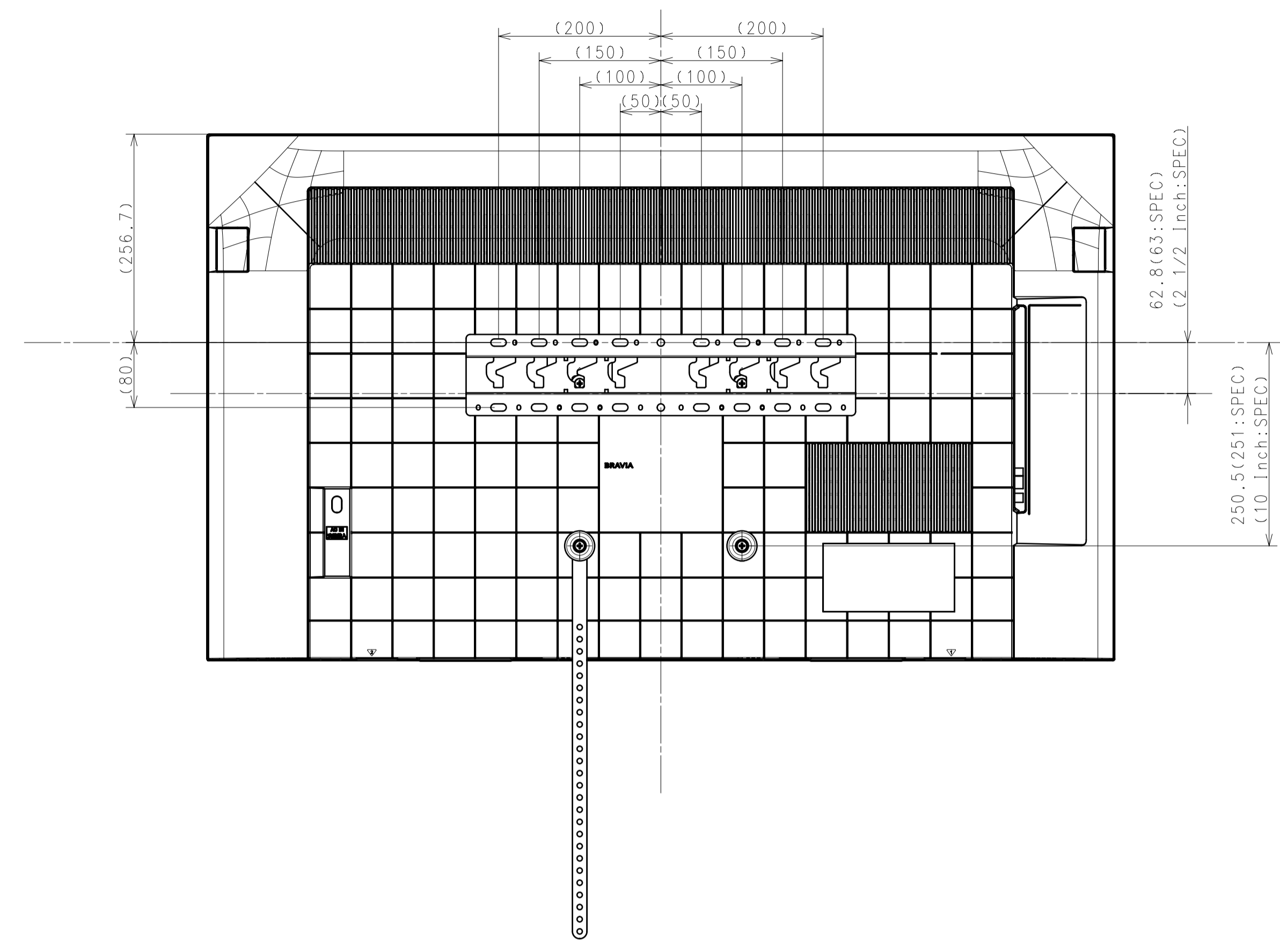

DRAWING

SONY STANDARD

DESCRIPTION 1	LEGAL OWNER	SCALE
50(X90S) EXTERIOR VIEW	Sony Corporation	1:5
DESCRIPTION 2	PART NO.	SHEET/PAGES
50(X90S) EXTERIOR VIEW		4 / 4