

# marantz

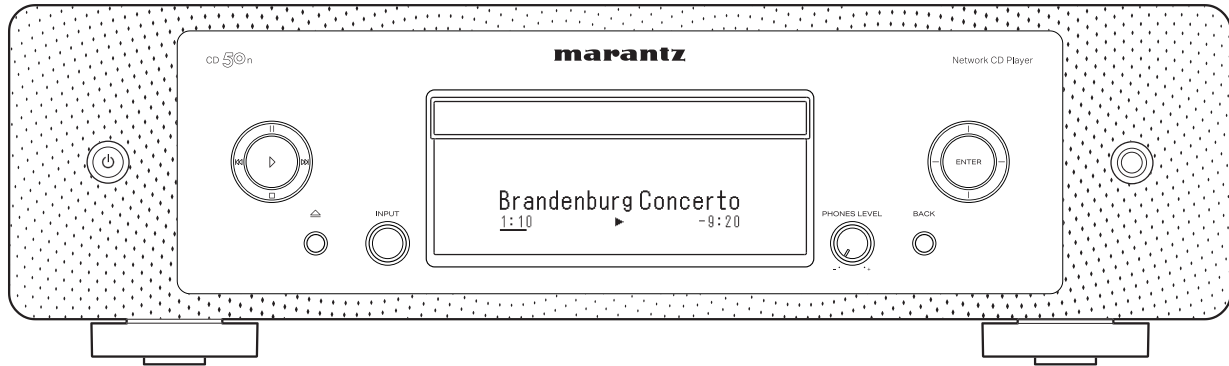

CD50n | Network CD Player

QUICK START GUIDE

# Before you begin

## What's in the box

Quick Start Guide

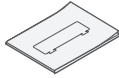

Network CD Player



Audio cable



Safety instructions



Power cord



Remote connector cable

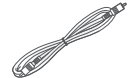

Cautions on using batteries

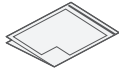

Remote control (RC003PMND)



External antennas for Bluetooth®/Wi-Fi® connectivity



Notes on radio

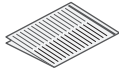

2× R03/AAA batteries



## Required for setup

---

Amplifier

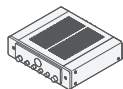

Speakers



Speaker cables



Mobile device



Wi-Fi Router and  
Internet connection



## Optional

---

HDMI® cable



Ethernet cable



Computer



USB cable

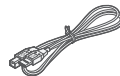

# Setup

## 1 Connect the antennas

- 1 Place the antenna evenly over the antenna terminal located at the upper left or right corner of the rear panel.
- 2 Turn the antenna clockwise until it is fully connected. Do not over tighten.
- 3 Rotate the antenna upwards for the best possible reception.

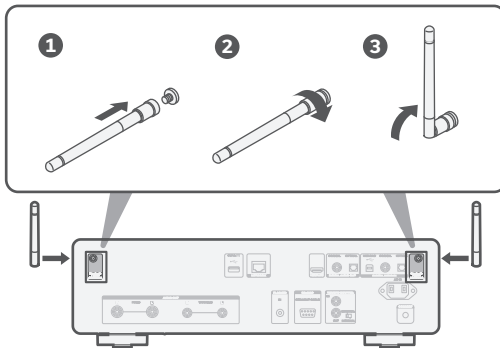

### NOTE

The antennas are required for both Bluetooth and Wi-Fi functions.

## Optional

If you are connecting CD 50n to a wired network, connect an Ethernet cable (not included) between the player and your router. Do not connect the Ethernet cable if you are connecting the player to a wireless network.

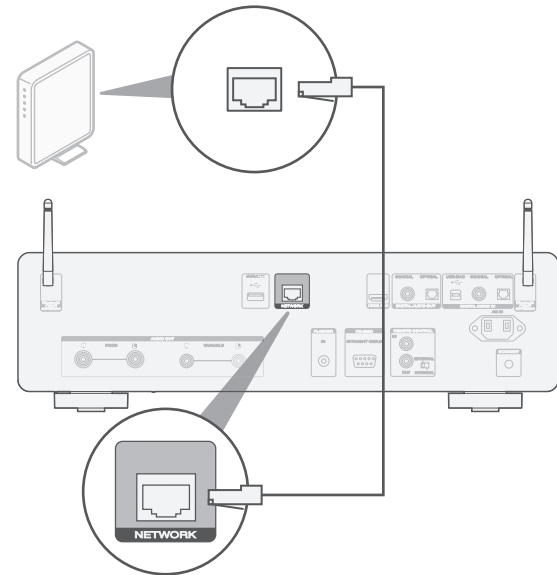

- In step 6 we will guide you how to connect to a wireless network.

## 2 Connect the player to your amplifier

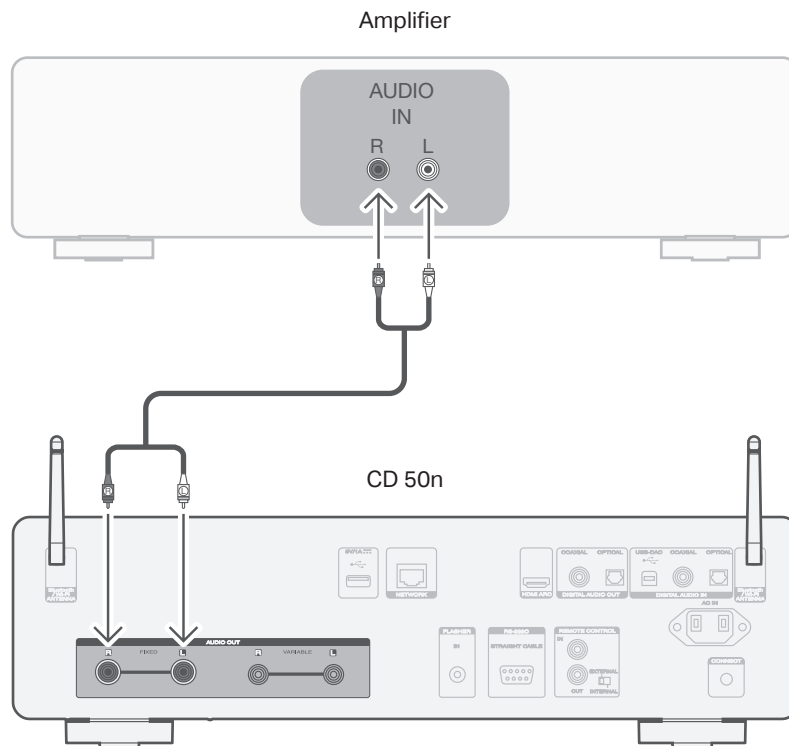

### 3 Connect TV audio (optional)

- 1 Connect one end of the HDMI cable to the TV port labeled "ARC" or "eARC".  
The CD 50n does not support eARC functionality, however you can still connect it to an eARC port to use ARC functionality.
- 2 Connect the other end of the HDMI cable to the HDMI ARC port on the back of the CD 50n.

#### NOTE

- The TV connection is used to pass audio to the CD 50n from your TV's built-in sources (tuner, smart TV apps, etc.) and HDMI devices connected to your TV. The CD 50n does not generate any video output.
- Make sure the audio output section in your TV settings menu is set to output only 2ch PCM audio. Dolby Digital and DTS audio are not supported.

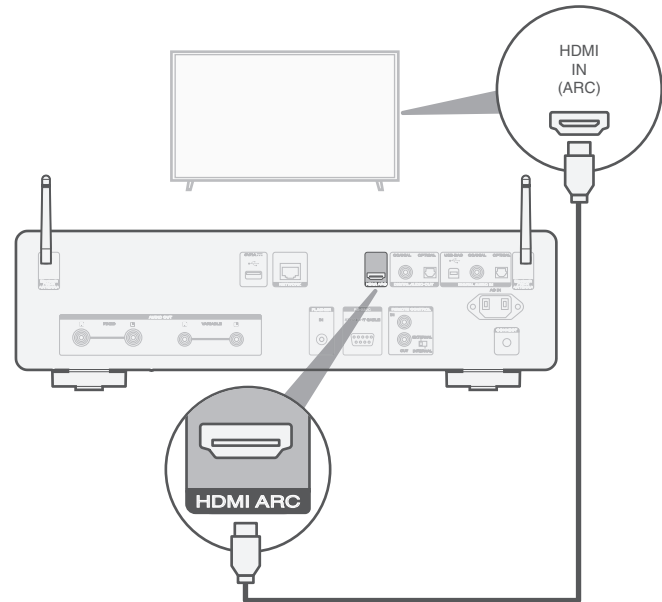

## 4 Connect to power

Connect the power cord between the CD 50n and a wall outlet.

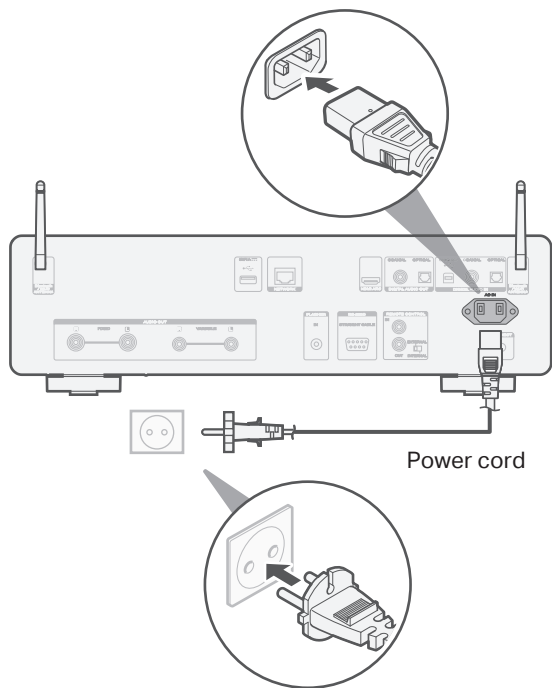

## 5 Install batteries in the receiver remote control

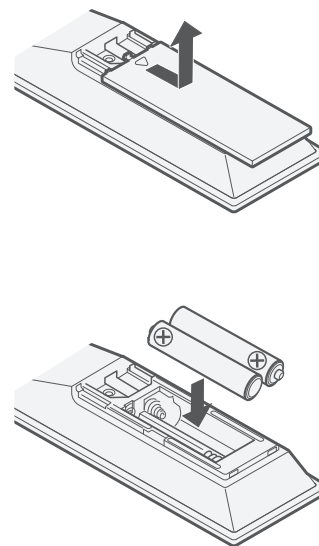

- Batteries can be taken out in reversed order.

## 6 Use the HEOS app to complete CD 50n setup

### First time setting up HEOS Built-in device

- 1 Go to the Apple App Store, Google Play or Amazon App Store and search for "HEOS" to download and install.



- 2 Launch the HEOS app and follow the instructions in the app.

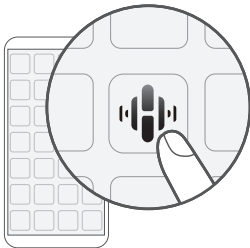

### I have setup at least one HEOS built-in device on my network

If you already have the HEOS app and have setup at least one HEOS built-in device, please follow the steps below to add the CD 50n to your wireless network.

- 1 Select the Settings  icon in the upper-right corner of the main "Home" menu to display the Settings menu.

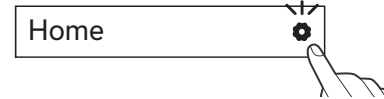

- 2 Select "Add Device" from the HEOS app's Settings menu and follow the instructions:



- You will need to use the CONNECT button on the rear panel of this unit when connecting this unit to a wireless LAN network. Place this unit in a position where the CONNECT button is within reach until the network configuration is complete. If you cannot reach the CONNECT button, you can also use the HEOS button on the remote control. Instead of the CONNECT button, press and hold the HEOS button for at least 2 seconds.



## 7 Enjoy your music

### Enjoy Internet Radio

- 1 Press INTERNET RADIO.
- 2 Select the station you want to play, then press ENTER.
- 3 Select "Play Now", then press ENTER.



- Using the HEOS app to control your device and select your favorite TuneIn radio station to play on your device.

### Enjoy music using Apple AirPlay

- 1 Open Control Center then tap the AirPlay icon in the audio card.
- 2 Select "Marantz CD 50n" from the AirPlay Device list.
- 3 Choose music to play from your iPhone, iPod touch, or iPad.

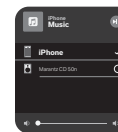

- You can also AirPlay audio from an app you're using on your iOS device. Just open the app, tap the AirPlay icon, then tap a speaker or tap multiple speakers.

## Enjoy music using Bluetooth

- 1 Press Bluetooth to select Bluetooth.  
When you use it for the first time, the player automatically enters pairing mode.

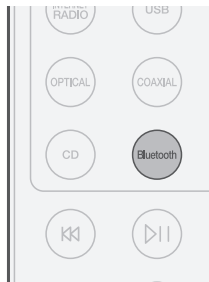

- 2 Activate Bluetooth on your mobile device.

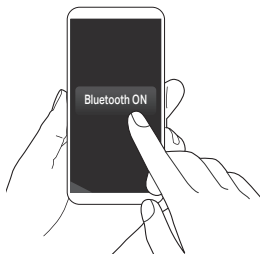

- 3 Select "Marantz CD 50n" from the Bluetooth device list on your mobile device.

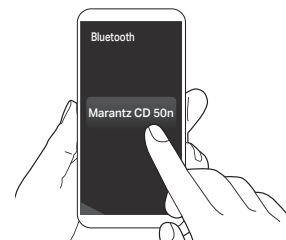

- 4 Play music using any app on your mobile device.

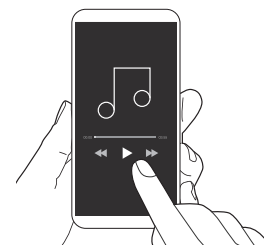

- To pair with other Bluetooth devices, press and hold Bluetooth on the remote control for at least 3 seconds.

## 8 Listen to computer audio via USB-DAC

### 1 Install the Windows driver software

#### NOTE

The installation of the driver software is not necessary in the following cases.

- When you do not play back the music from a PC using USB-DAC of this unit.
- When using a macOS.

The driver software cannot be installed correctly if your PC is connected to the unit by a USB cable. If the unit and your computer are connected by a USB cable and the computer is switched on before installation, disconnect the USB and restart the computer.

#### Windows OS

System requirements : Windows 10 or Windows 11

- 1 Download the dedicated driver from the “Download” section of the CD 50n page of the Marantz website ([www.marantz.com](http://www.marantz.com)) onto your PC.
- 2 Unzip the downloaded file, and double-click the exe file.

### 3 Install the driver.

- 1 Select the language to use for the installation.
- 2 Click “OK”.

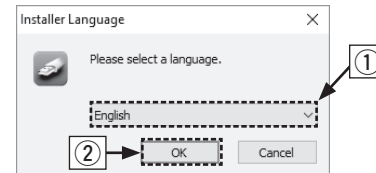

- 3 The wizard menu is displayed. Follow the instructions on the screen.
- 4 When the wizard is completed, click “Yes”.



#### NOTE

Please see the FAQ at [www.marantz.com](http://www.marantz.com) if you experience any issues getting audio to play from your computer through the CD 50n. You may also want to check the support pages for audio player application.



## 2 Connect to PC or Mac

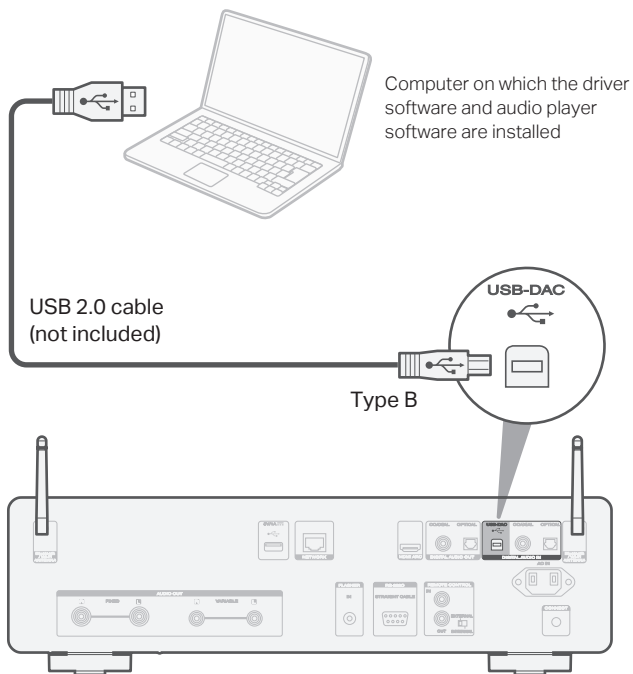

## 3 Listen to audio from PC or Mac

- 1 Power on.
- 2 Press USB-DAC to switch the input source to "USB-DAC".
- 3 Set the audio signal destination to this unit on the computer.



### Windows OS

- 1 Open the "Control Panel" on the PC.
  - The control panel setting list is displayed.
- 2 Click the "Sound" icon.
  - The sound menu window is displayed.

- ③ Check that there is a checkmark next to “Default Device” under in “CD 50n” of the “Playback” tab.
  - When there is a checkmark for a different device, click “CD 50n” and “Set Default”.
- ④ Select “CD 50n” and click “Properties”.
  - The CD 50n properties window is displayed.

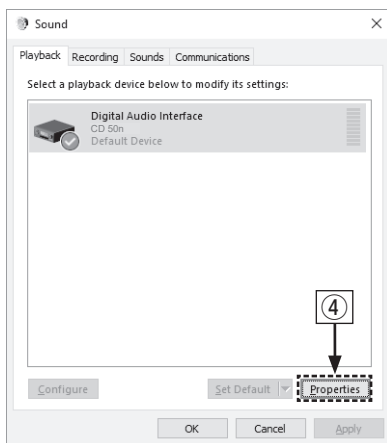

- ⑤ Click the “Advanced” tab.
- ⑥ Select the sampling rate and bit rate to be applied to the D/A converter.
  - It is recommended that “2 channel, 32 bit, 192000 Hz (Studio Quality)” is selected.
- ⑦ Click “Apply”.
- ⑧ Click “Test”.
  - Check that audio from this unit is output from the PC.

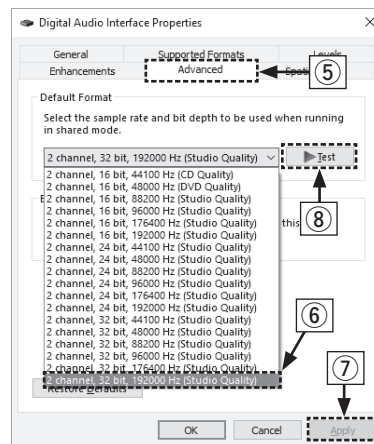

## macOS

System requirements: macOS 12 or 13

- ① Move the cursor to “Go” on the computer screen, and then click “Utilities”.
  - The utility list is displayed.
- ② Double-click “Audio MIDI Setup”.
  - The “Audio Devices” window is displayed.
- ③ Secondary click on “CD 50n”, and then check that “Use This Device For Sound Output” is checked.
  - If a different device is checked, select and secondary click on “CD 50n”, and then select “Use This Device For Sound Output”.

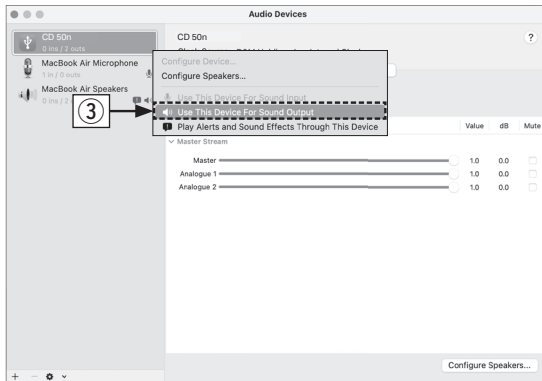

- ④ Select the “CD 50n” format.
  - It is normally recommended to set the format to “2 ch 32-bit Integer 384.0 kHz”.

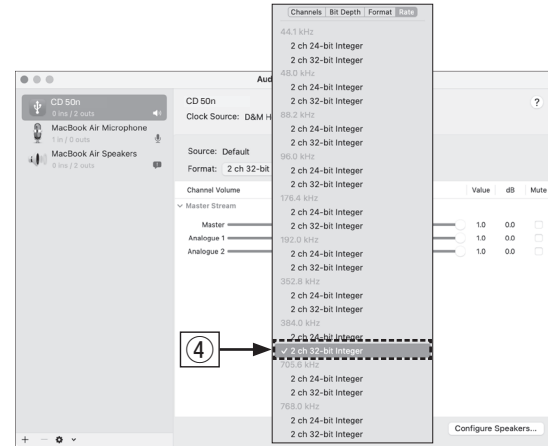

- ⑤ Quit Audio MIDI Setup.

**4 Use your favorite music applications on your PC/Mac to play audio through the CD 50n.**

For high resolution audio playback you will need to obtain an advanced audio player software such as JRiver Media Center or Audirvana.

**NOTE**

Additional settings to output audio to the CD 50n may have to be selected in your advanced audio player application. Please refer to the user's manual for your application.

# Contact Marantz

 **00800-43674357**

We hope you will enjoy your Marantz product for years to come. If you ever have any question or need any support, just get in touch via the free helpline. We are happy if you are happy.

In case you can't reach the helpline please check the support section on **[www.marantz.com](http://www.marantz.com)** for more information.

# Owner's manual

Refer to the online manual for other functions, information and operation procedure details.

**[manuals.marantz.com/CD50n/EU/EN/](http://manuals.marantz.com/CD50n/EU/EN/)**



Online manual

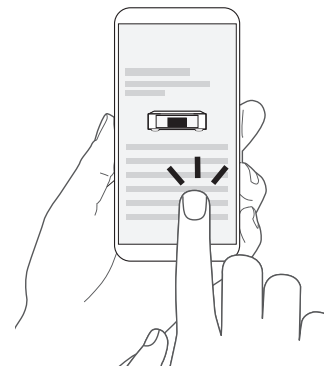



## Trademark information



Apple, AirPlay, iPad, iPad Air, iPad Pro and iPhone are trademarks of Apple Inc., registered in the U.S. and other countries. The trademark "iPhone" is used in Japan with a license from Aiphone K.K.

Use of the Works with Apple badge means that an accessory has been designed to work specifically with the technology identified in the badge and has been certified by the developer to meet Apple performance standards.



The Bluetooth® word mark and logos are registered trademarks owned by the Bluetooth SIG, Inc. and any use of such marks by DEI Sales, Inc. is under license. Other trademarks and trade names are those of their respective owners.



The Wi-Fi CERTIFIED logo is a registered trademark of the Wi-Fi Alliance. Wi-Fi Certification provides assurance that the device has passed the interoperability test conducted by the Wi-Fi Alliance, a group that certifies interoperability among wireless LAN devices.



The terms HDMI, HDMI High-Definition Multimedia Interface, HDMI trade dress and the HDMI Logos are trademarks or registered trademarks of HDMI Licensing Administrator, Inc.



App Store® is registered in the U.S. and other countries.



Google Play and the Google Play logo are trademarks of Google LLC.

**marantz**