

# marantz

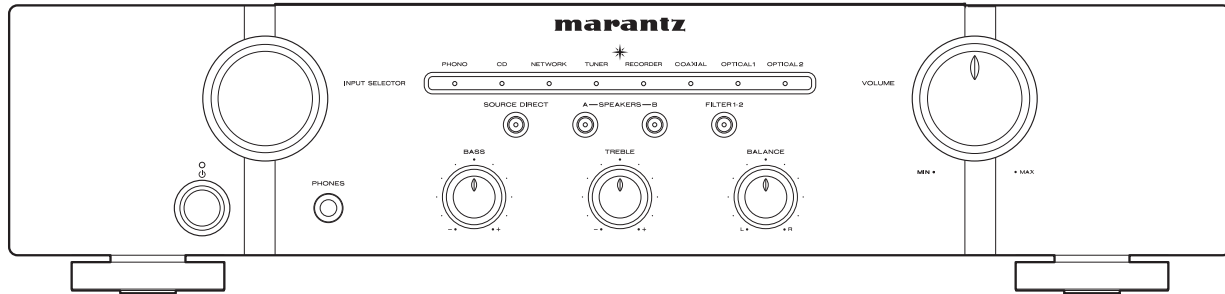

PM6007 | Integrated Amplifier

QUICK START GUIDE

# Welcome

Thank you for choosing a Marantz amplifier. This guide provides step-by-step instructions for setting up your amplifier.

# Before You Begin

## What's In the Box

Quick Start Guide

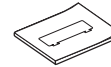

Amplifier

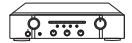

Owner's Manual



Power cord



Safety Instructions



Remote control unit (RC004PMCD)



Cautions on Using Batteries

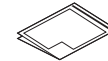

R03/AAA batteries



## Required for Setup

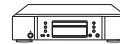

CD Player



Speaker systems



Speaker cables



These drawings are for illustrative purposes only and may not represent the actual product(s).

# Setup

There are six steps to the setup process.

- 1 Install batteries in the remote control unit
- 2 Connect the speakers to PM6007
- 3 Connect the CD player to PM6007
- 4 Plug the power cord into a power outlet
- 5 Turn on the power of PM6007 and then set the speakers for audio output to SPEAKERS A
- 6 Begin CD playback

## 1 Install batteries in the remote control unit

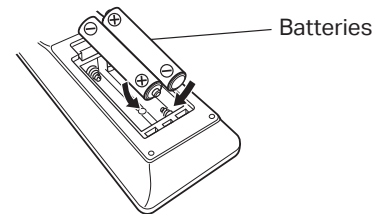
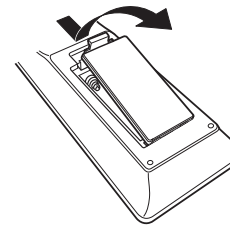

## 2 Connect the speakers to PM6007

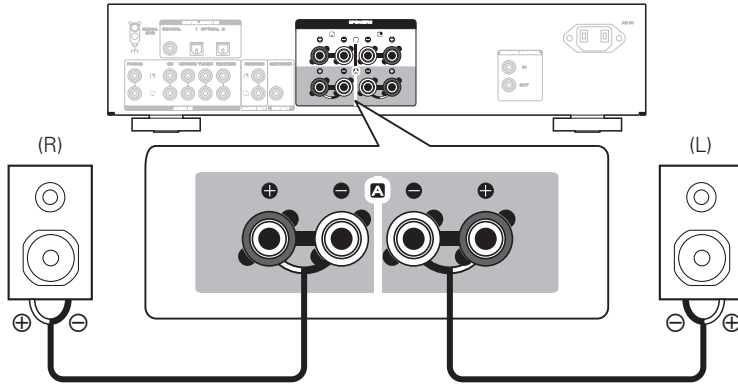

### Connecting the speaker cables

- 1 Peel off about 10 mm of sheathing from the tip of the speaker cable, then either twist the core wire tightly or apply solder to it.
- 2 Turn the speaker terminal counterclockwise to loosen it.
- 3 Insert the speaker cable's core wire to all the way into the speaker terminal.
- 4 Turn the speaker terminal clockwise to tighten it.



### 3 Connect the CD player to PM6007

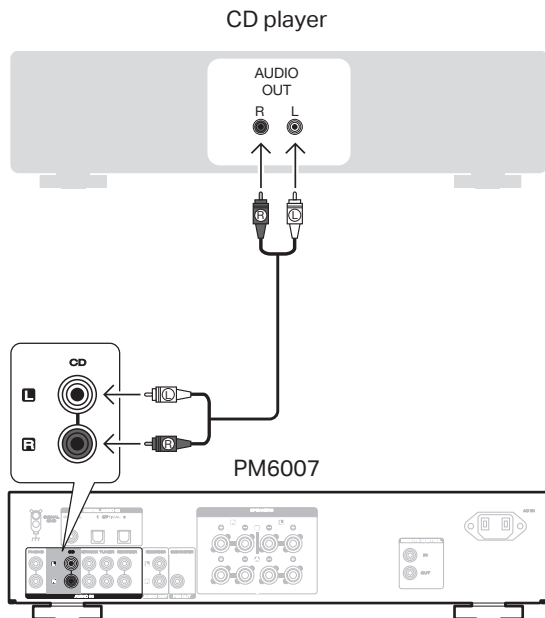

### 4 Plug the power cord into a power outlet

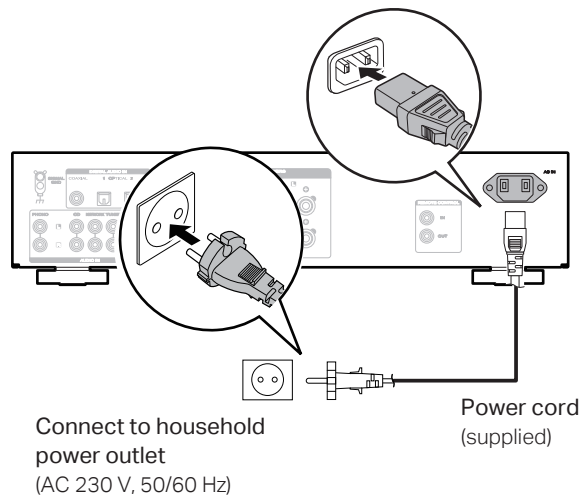

## 5 Turn on the power of PM6007 and then set the speakers for audio output to **SPEAKERS A**

- 1 Reduce the volume to the minimum level.

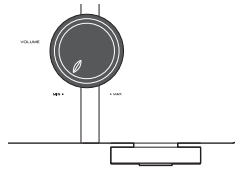

- 2 Press the power operation button.

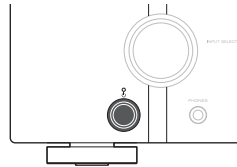

- 3 Press **SPEAKERS A**. The **SPEAKERS A** indicator lights and the speakers for audio output are set to **SPEAKERS A**.

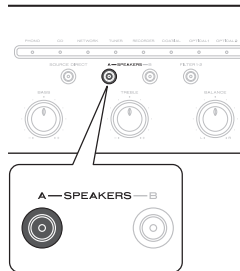

## 6 Begin CD playback

- 1 Set the input source to "CD".

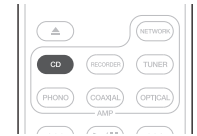

- 2 Play the CD player.

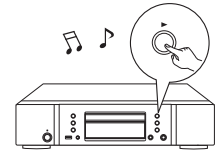

- 3 Adjust the volume.

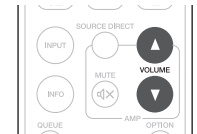

# Owner's Manual

- Refer to the Online Manual for other functions information and operation procedure details.

**[manuals.marantz.com/PM6007/EU/EN/](http://manuals.marantz.com/PM6007/EU/EN/)**



Online Manual

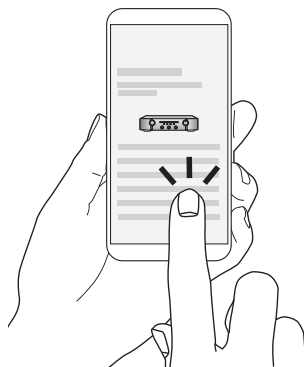

- For more information, visit **[www.marantz.com](http://www.marantz.com)**

**[www.marantz.com](http://www.marantz.com)**

You can find your nearest authorized distributor or dealer on our website.

**marantz** is a registered trademark.