



**marantz®**

Integrated Amplifier  
**MODEL 30**

Owner's Manual

Front panel

Rear panel

Remote control  
unit

Index



<b>Accessories</b>	<b>4</b>
Inserting the batteries	5
Operating range of the remote control unit	5
<b>Part names and functions</b>	<b>6</b>
Front panel	6
Rear panel	9
Remote control unit	11

## Connections

<b>Connecting speakers</b>	<b>15</b>
Speaker connection	16
<b>Connecting a playback device</b>	<b>17</b>
<b>Connecting a recording device</b>	<b>18</b>
<b>Connecting a pre-amplifier or power amplifier</b>	<b>19</b>
<b>Connecting devices with remote control connectors</b>	<b>20</b>
Performing operations by RC on this unit without visual contact	20
Remotely connecting Marantz audio devices	20
<b>Connecting the power cord</b>	<b>21</b>

## Playback

Turning the power on	23
Switching the power to standby	23
Selecting the input source	24
Adjusting the volume	24
Turning off the sound temporarily (Muting)	24
Adjusting the tone and balance	24
Playing CDs	25
Using this unit as a power amplifier	25
Recording	26



## Settings

<b>Setting the display's brightness</b>	<b>28</b>
<b>Setting the lighting LED brightness</b>	<b>29</b>
<b>Setting the Auto Standby mode</b>	<b>30</b>
<b>Setting remote control codes</b>	<b>31</b>
Setting remote control codes for the remote control	32
Setting remote control codes for the main unit	32

## Tips

<b>Tips</b>	<b>34</b>
<b>Troubleshooting</b>	<b>35</b>
Power does not turn on / Power is turned off	36
Operations cannot be performed through the remote control unit	37
Display on this unit shows nothing	37
No sound comes out	38
Desired sound does not come out	38
Sound is interrupted or noise occurs	39

## Appendix

<b>Explanation of terms</b>	<b>40</b>
<b>Specifications</b>	<b>41</b>
<b>Index</b>	<b>44</b>







Thank you for purchasing this Marantz product.

To ensure proper operation, please read this owner's manual carefully before using the product.

After reading this manual, be sure to keep it for future reference.

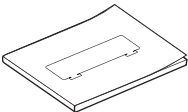
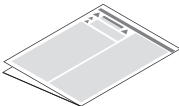
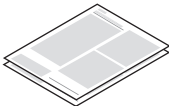
## Accessories

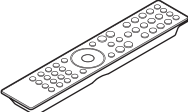
Check that the following parts are supplied with the product.

 Quick Start Guide	 Safety Instructions	 Warranty (for USA/for CANADA)	 Power cord
 Remote control unit (RC002PMND)	 R03/AAA batteries		



## Inserting the batteries

- 1 Remove the rear lid in the direction of the arrow and remove it.

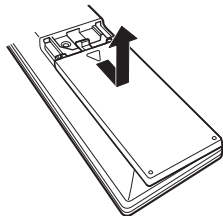

- 2 Insert two batteries correctly into the battery compartment as indicated.

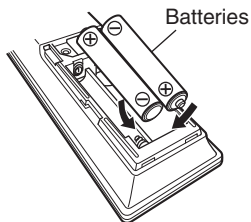

- 3 Put the rear lid back on.

### NOTE

- To prevent damage or leakage of battery fluid:
  - Do not use a new battery together with an old one.
  - Do not use two different types of batteries.
- Remove the batteries from the remote control unit if it will not be in use for long periods.
- If the battery fluid should leak, carefully wipe the fluid off the inside of the battery compartment and insert new batteries.

## Operating range of the remote control unit

Point the remote control unit at the remote sensor when operating it.

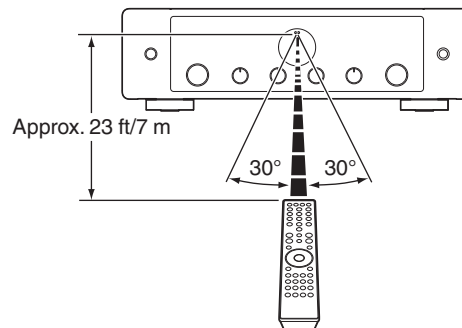

## Part names and functions

### Front panel

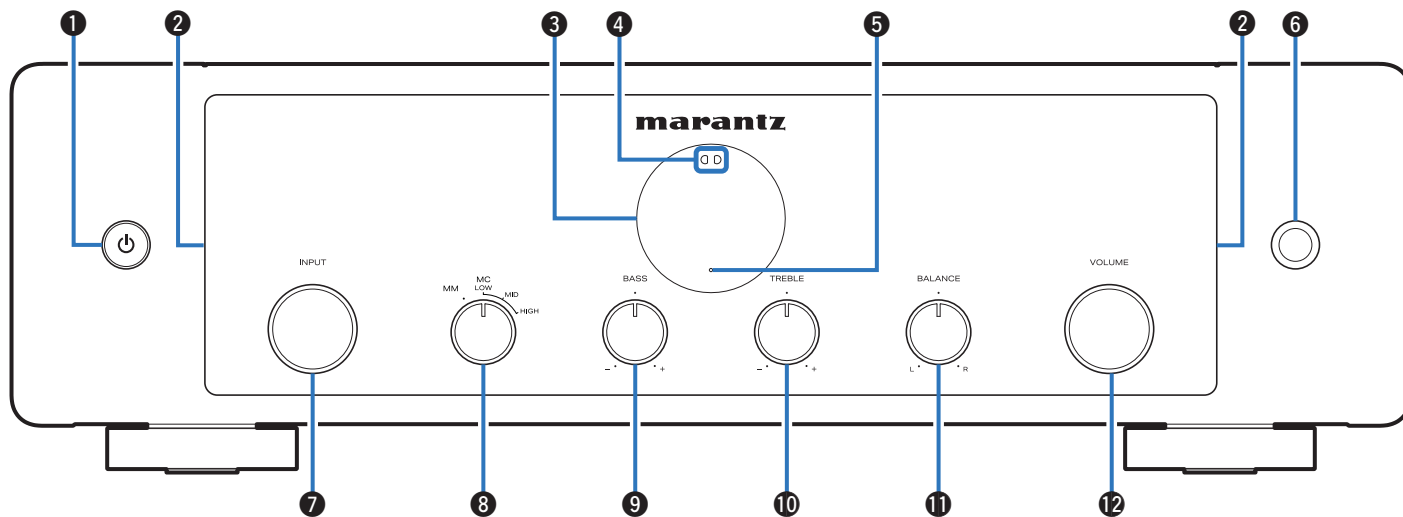

For details, see the next page.



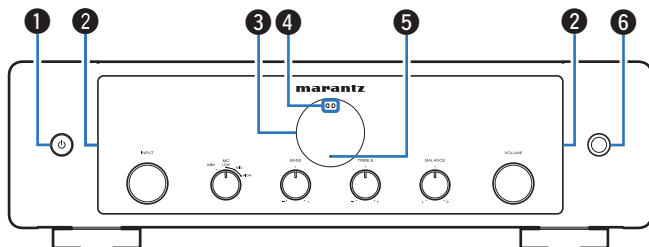

### ❶ Power operation button (⏻)

This turns the power on/off (standby). (👉 p. 23)

### ❷ Lighting LED

This illuminates when the power is turned on. Brightness can be changed and lighting turned off. (👉 p. 29)

### ❸ Display

This displays various pieces of information.

### ❹ Remote control sensor

This receives signals from the remote control unit. (👉 p. 5)

### ❺ Protection circuit indicator

This blinks when the protection circuit has operated. (👉 p. 36)

### ❻ Headphones jack (PHONES)

Used to connect headphones.

When the headphones are plugged into this jack, audio will no longer be output from the connected speakers and from the PRE OUT connectors.

#### NOTE

- To prevent hearing loss, do not raise the volume level excessively when using headphones.



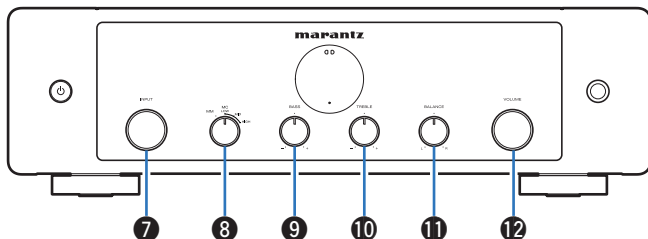

### 7 INPUT selector knob

This selects the input source. (☞ p. 24)

### 8 Cartridge selector knob

This switches between MM/MC cartridge and selects MC cartridge input impedance. Sets the phono equalizer of this unit according to the type or impedance of the turntable cartridge to be connected.

**MM:** Set this for an MM cartridge.

**MC LOW (33 Ω/ohms) :** Use this setting for an MC cartridge of less than 50 Ω/ohms.

**MC MID (100 Ω/ohms) :** Use this setting for an MC cartridge of about 50 Ω/ohms.

**MC HIGH (390 Ω/ohms) :** Use this setting for an MC cartridge of 100 Ω/ohms or higher.



- For an MC cartridge, select the input impedance closest to the impedance recommended for the cartridge used or select a value a few times that of the cartridge's internal impedance.
- If this setting change operation is performed, playback sound is output approximately 4 seconds after the change.

### 9 BASS control knob

This setting adjusts the volume level for the bass. (☞ p. 24)

### 10 TREBLE control knob

This setting adjusts the volume level for the treble. (☞ p. 24)

### 11 BALANCE control knob

This adjusts the balance of the volume output from the left and right speakers. (☞ p. 24)

### 12 VOLUME knob

These adjust the volume level. (☞ p. 24)



- 9, 10 and 11 can be adjusted when tone balance control is on. (☞ p. 24)





## Rear panel

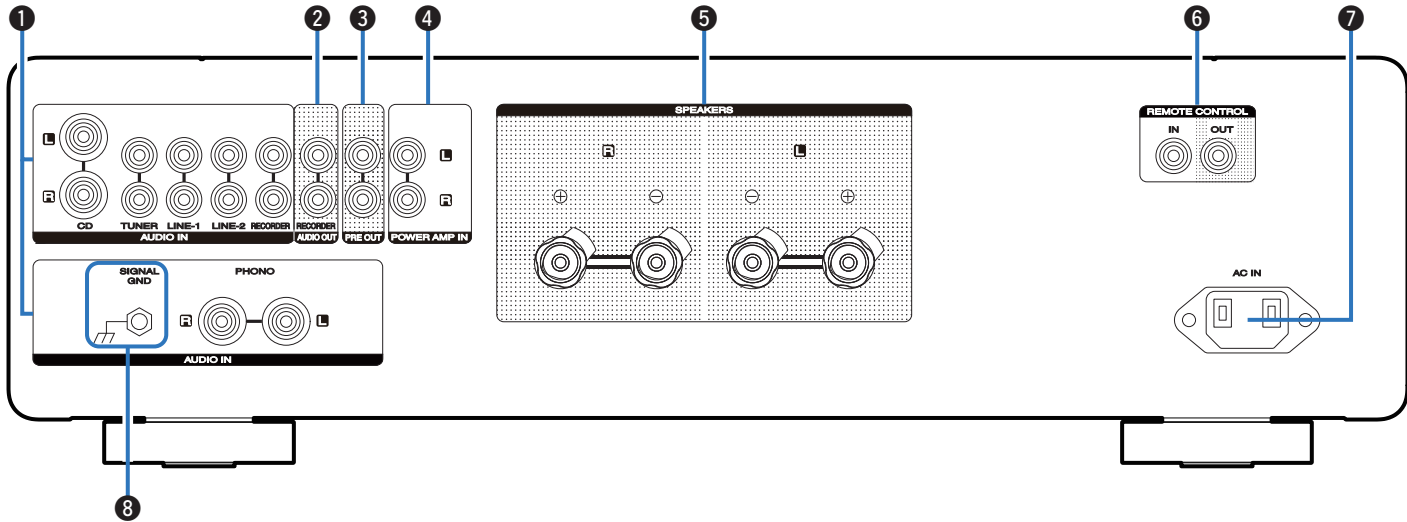

For details, see the next page.



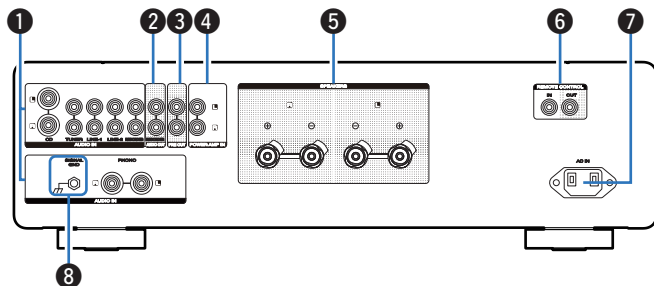

### 1 Analog audio input connectors (AUDIO IN)

Used to connect devices equipped with analog audio output connectors.

- “Connecting a playback device” (☞ p. 17)
- “Connecting a recording device” (☞ p. 18)

### 2 AUDIO OUT connectors (RECORDER)

Used to connect the input connector of a recorder. (☞ p. 18)

### 3 PRE OUT connectors

Use this to add such equipment as a power amplifier or subwoofer. (☞ p. 19)



- When connecting a subwoofer, also consult the subwoofer instruction manual.

### 4 Power amplifier connectors (POWER AMP IN)

Used to connect a pre-amplifier when this unit is used as a power amplifier. (☞ p. 19)

### 5 Speaker terminals (SPEAKERS)

Used to connect speakers. (☞ p. 15)

### 6 Remote control input/output connectors (REMOTE CONTROL)

Used to connect to a Marantz audio device that is compatible with the remote control function. (☞ p. 20)

### 7 AC inlet (AC IN)

Used to connect the power cord. (☞ p. 21)

### 8 SIGNAL GND terminal

Used to connect the ground wire of a turntable. (☞ p. 17)



## Remote control unit

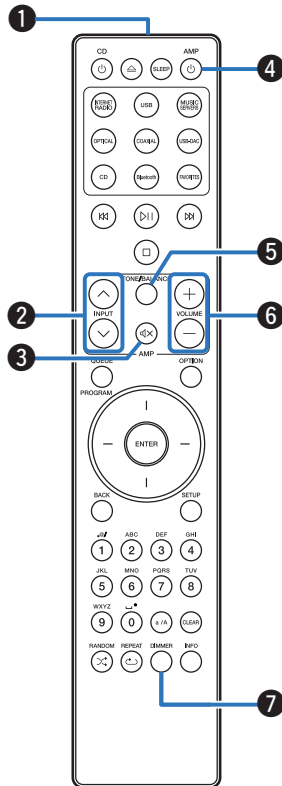

The remote control provided with this unit can control a Marantz Network SACD player.

- “Network SACD player operations” (👉 p. 12)

### ■ Operating this unit

#### 1 Remote control signal transmitter

This transmits signals from the remote control unit. (👉 p. 5)

#### 2 INPUT buttons (▲▼)

This selects the input source. (👉 p. 24)

#### 3 Mute button (🔇)

This mutes the output audio. (👉 p. 24)

#### 4 Power operation button (AMP ⏻)

- This turns the power on/off (standby). (👉 p. 23)
- This turns Auto Standby mode on/off. (👉 p. 30)

#### 5 TONE/BALANCE button

- This turns tone balance control on/off. (👉 p. 24)
- The lighting setting menu appears on the display. (👉 p. 29)

#### 6 VOLUME buttons (⊕⊖)

These adjust the volume level. (👉 p. 24)

#### 7 DIMMER button

Adjust the display brightness of this unit. (👉 p. 28)



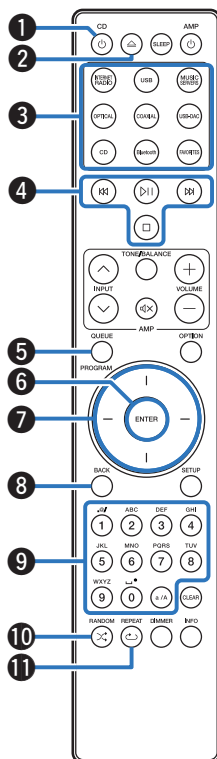

## ■ Network SACD player operations

A Marantz Network SACD player can be operated.

- 1 Power operation button (CD  $\phi$ )
- 2 Disc tray open/close button ( $\triangle$ )
- 3 Input source select buttons
- 4 System buttons
- 5 QUEUE button  
PROGRAM button
- 6 ENTER button
- 7 Cursor buttons
- 8 BACK button
- 9 Number/letter buttons (0 – 9, a/A)
- 10 RANDOM button ( $\times$ )
- 11 REPEAT button ( $\curvearrowright$ )



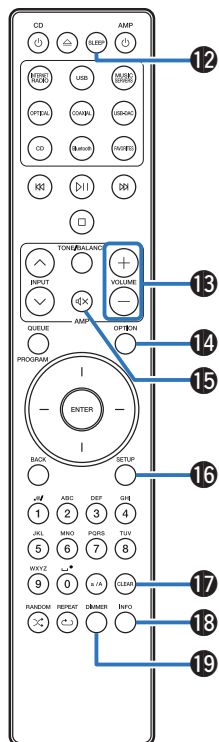

12 SLEEP button

13 VOLUME buttons (+/-)

14 OPTION button

15 Mute button (M)

16 SETUP button

17 CLEAR button

18 Information button (INFO)

19 DIMMER button



- The remote control may not operate some products.
- 18 and 15 only work when the remote control code is set to Network SACD player operation mode. See the instruction manual of your Marantz Network SACD player for details.



## ■ Contents

Connecting speakers	15
Connecting a playback device	17
Connecting a recording device	18
Connecting a pre-amplifier or power amplifier	19
Connecting devices with remote control connectors	20
Connecting the power cord	21

### NOTE

- Do not plug in the power cord until all connections have been completed.
- Do not bundle power cords together with connection cables. Doing so can result in humming or noise.

## ■ Cables used for connections

Provide necessary cables according to the devices you want to connect.

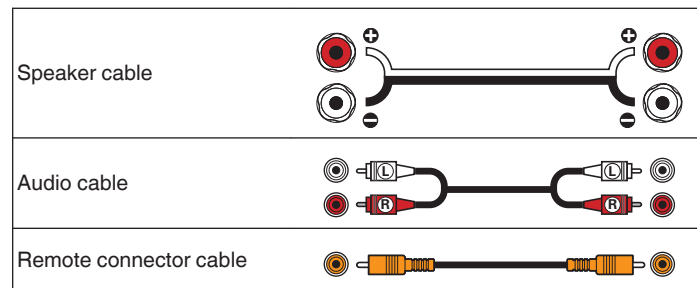

# Connecting speakers

## NOTE

- Disconnect this unit's power plug from the power outlet before connecting the speakers.
- Connect so that the speaker cable core wires do not protrude from the speaker terminal. The protection circuit may be activated if the core wires touch the rear panel or if the + and - sides touch each other. ("Protection circuit" (👉 p. 40))
- Never touch the speaker terminals while the power cord is connected. Doing so could result in electric shock.
- Use speakers with an impedance of 4 – 16  $\Omega$ /ohms.

## ■ Connecting the speaker cables

Carefully check the left (L) and right (R) channels and + (red) and - (white) polarities on the speakers being connected to this unit, and be sure to connect the channels and polarities correctly.

- 1** Peel off about 3/8 inch (10 mm) of sheathing from the tip of the speaker cable, then either twist the core wire tightly or terminate it.



- 2** Turn the speaker terminal counterclockwise to loosen it.

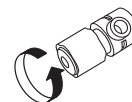

- 3** Insert the speaker cable's core wire to the hilt into the speaker terminal.

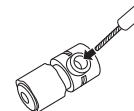

#### 4 Turn the speaker terminal clockwise to tighten it.

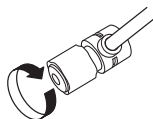

##### Spade lug connector



##### When using a banana plug

Tighten the speaker terminal firmly before inserting the banana plug.

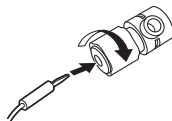

## Speaker connection

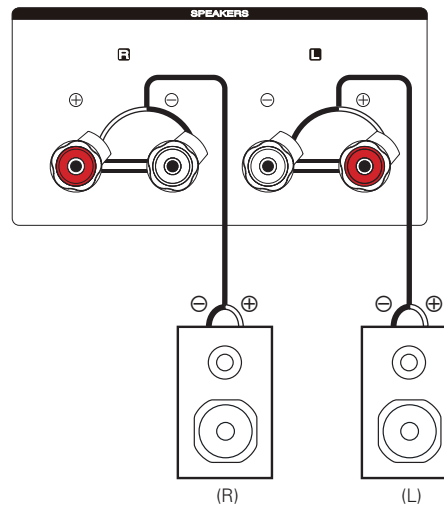



## Connecting a playback device

You can connect turntables, tuners, Blu-ray disc players, network audio players and CD players to this unit. Use the cartridge selector knob on the front panel to set the phono equalizer on this unit according to the type of turntable cartridge to be connected. (☞ p. 8)

If you set this unit's input source to "PHONO" and you accidentally increase the volume without having a turntable connected, you may hear a hum noise from the speakers.

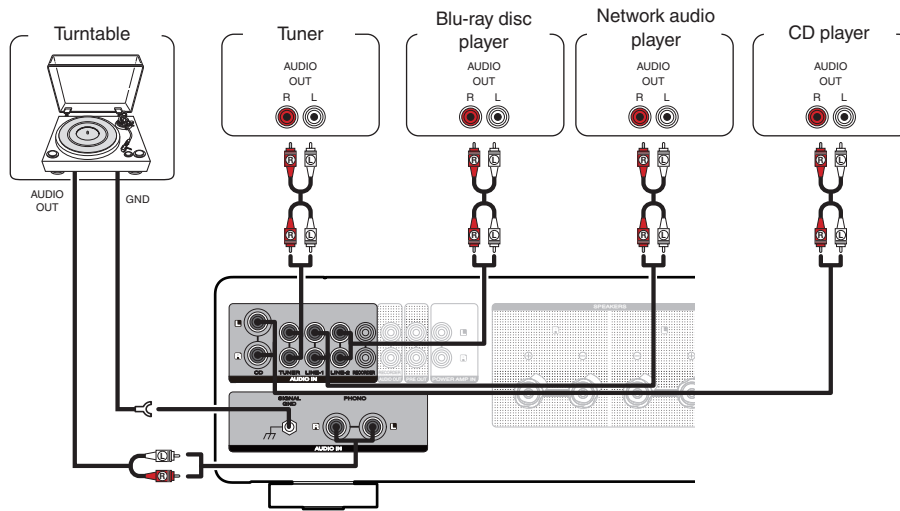

### NOTE

- The earth terminal (SIGNAL GND) of this unit is not for safety grounding purposes. If this terminal is connected when there is a lot of noise, the noise can be reduced. Note that depending on the turntable, connecting the ground line may have the reverse effect of increasing noise. In this case, it is not necessary to connect the ground line.



- The PHONO input terminals are equipped with a short pin-plug. Remove this plug to connect a record player. Store the removed short pin-plug in a safe place so as not to lose it.



## Connecting a recording device

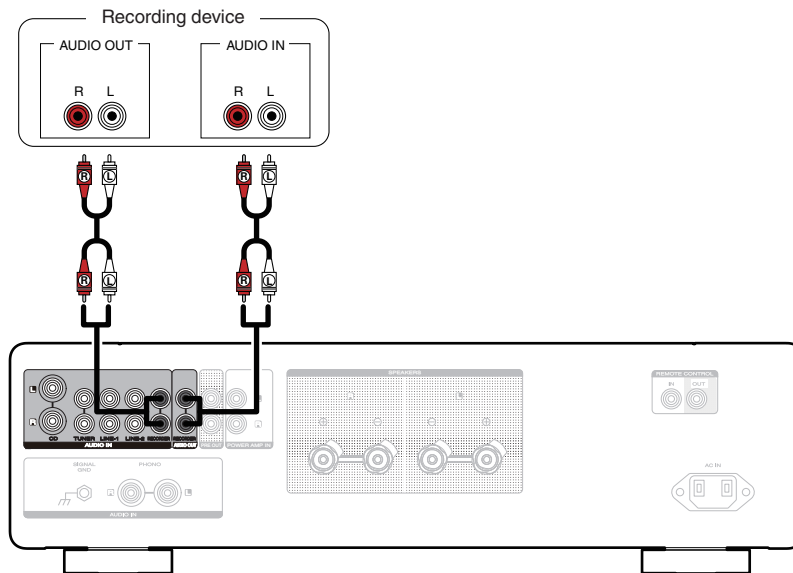

### NOTE

- Never insert the short-circuiting pin plug into the recording output connectors (AUDIO OUT RECORDER). Doing so could result in damage.



## Connecting a pre-amplifier or power amplifier

Connect a power amplifier to the unit to use it as a pre-amplifier, or connect a pre-amplifier to the unit to use it as a power amplifier.

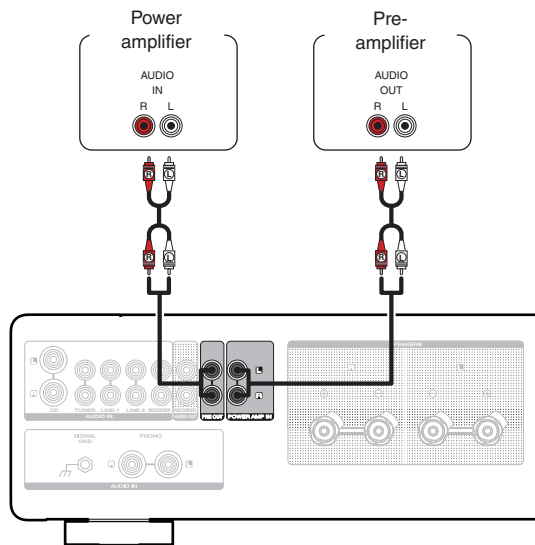

- When connecting a pre-amplifier and using this unit as a power amplifier, switch the input source to "PWR AMP". (🔍 p. 25)

### NOTE

- Never insert the short-circuiting pin plug into the PRE OUT connectors. Doing so could result in damage.



## Connecting devices with remote control connectors

### Performing operations by RC on this unit without visual contact

You can connect an external IR receiver to the REMOTE CONTROL connectors to perform operations on this unit with the supplied remote control unit without visual contact. This might be necessary if the unit is hidden in a cupboard or corner, so you can't directly point with the remote control unit to the device.

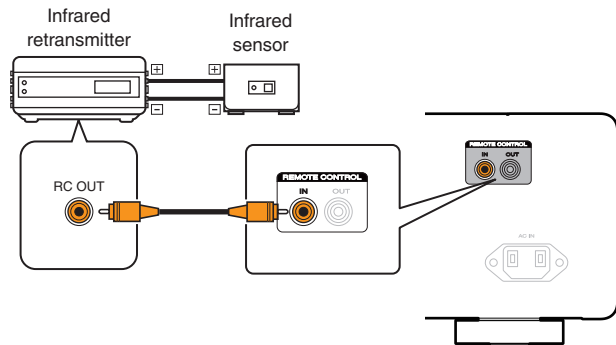

### Remotely connecting Marantz audio devices

You can transmit remote control signals simply by connecting a Marantz audio device to the REMOTE CONTROL IN/OUT connectors using the remote connection cable provided with the device.

Set the remote control switch located on the rear panel of the connected audio component to "EXTERNAL" to use this feature.

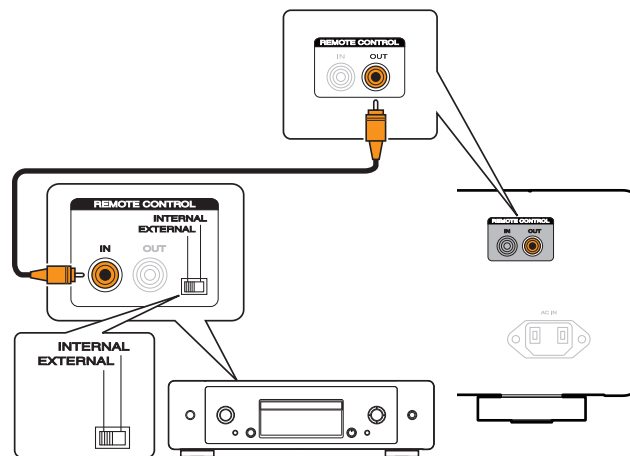

## Connecting the power cord

After completing all the connections, insert the power plug into the power outlet.

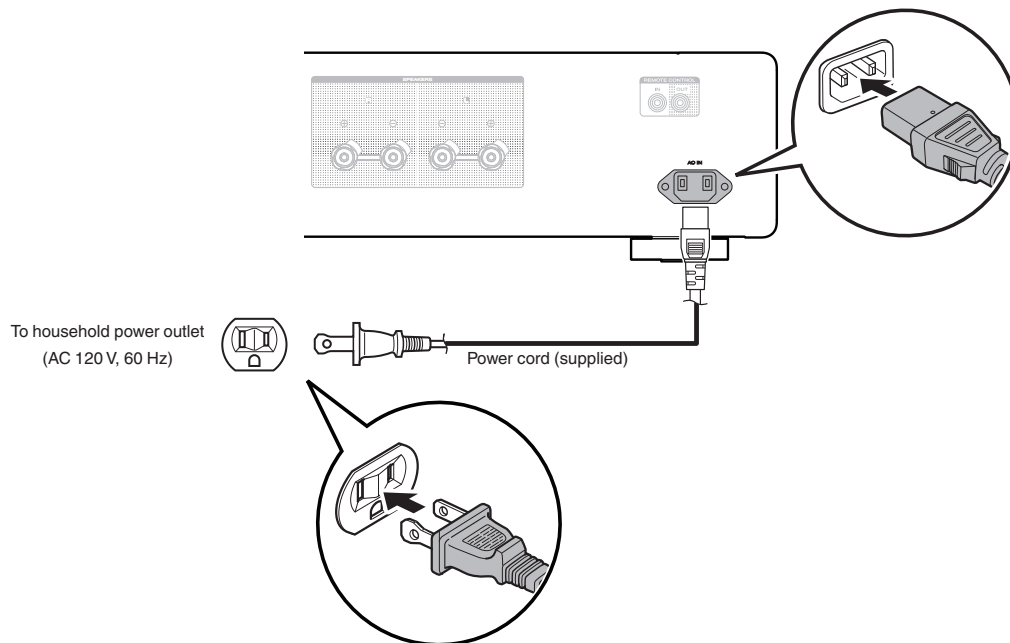

## ■ Contents

Turning the power on	23
Switching the power to standby	23
Selecting the input source	24
Adjusting the volume	24
Turning off the sound temporarily (Muting)	24
Adjusting the tone and balance	24
Playing CDs	25
Using this unit as a power amplifier	25
Recording	26



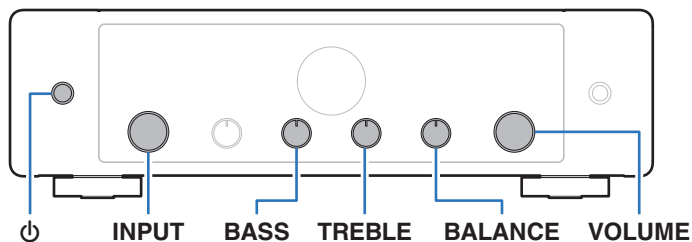
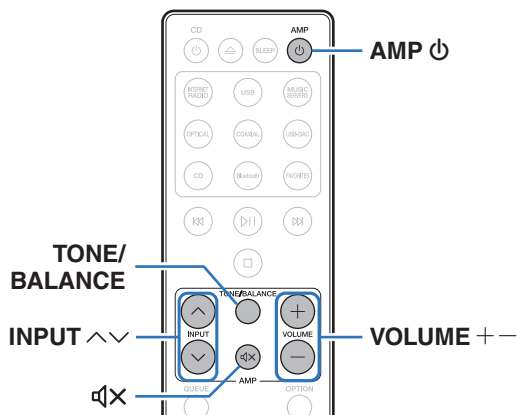

## Turning the power on

- 1 Press **AMP** to turn on power to the unit.  
The display turns on.



- You can also press on the main unit to turn on power from standby mode.

## Switching the power to standby

- 1 Press **AMP** .
- The unit switches to standby mode.

### NOTE

- Power continues to be supplied to some of the circuitry even when the power is in the standby mode. When leaving home for long periods of time or when going on vacation, unplug the power cord from the power outlet.



## Selecting the input source

- 1 Use **INPUT**  $\wedge$  $\vee$  to select the input source to be played back.

The selected input source appears on the display.



- You can also select the input source by turning INPUT selector on the main unit.

## Adjusting the volume

- 1 Use **VOLUME**  $+$  $-$  to adjust the volume.

The volume level appears on the display.



- You can also adjust the volume by turning VOLUME on the main unit.

## Turning off the sound temporarily (Muting)

- 1 Press **MUTE**.

"Mute" is displayed on the display.



- To cancel mute, either adjust the volume or press **MUTE** again.

## Adjusting the tone and balance

- 1 Press **TONE/BALANCE** to turn on tone balance control.

"TONE/BALANCE" is displayed on the display.

- The tone and balance adjustment circuitry (BASS, TREBLE, and BALANCE) is activated.





- 2 Turn the **BASS**, **TREBLE** and **BALANCE** on the main unit to adjust the tone and balance.





## Playing CDs

This section uses playback from a CD as an example.



- 1 Press **AMP**  to turn the power on.
- 2 Use **INPUT**   to switch the input source to “CD”.  
“CD” is displayed on the display.
- 3 Playback the CD.
- 4 Use **VOLUME**   to adjust the volume.

## Using this unit as a power amplifier

When connecting a pre-amplifier and using this unit as a power amplifier, switch the input source of this unit to “PWR AMP”.

- 1 Turn the **INPUT** selector on the main unit to switch the input source to “PWR AMP”.  
“PWR AMP” is displayed on the display.



- When the input source is “PWR AMP”, adjustment of the volume, balance and tone has no effect. Adjust these adjustments on the pre-amplifier.
- When the remote control code setting is set to “AMP1” (Default), **INPUT**   on the remote control cannot be used to switch the input source to “PWR AMP” or switch from “PWR AMP” to another input source. To make remote control operations, change the remote control code setting to “AMP2” or “AMP3”.  
( p. 31)



### NOTE

- When the input source is “PWR AMP”, the main unit outputs at maximum volume. Check the output level on the input device before playing it and adjust the volume accordingly.



## Recording

Audio signals input into this unit can be output to an external recording device. When recording audio from a playback device connected to this unit, audio can be recorded with the playback device still connected to this unit.

- 1 Press AMP  to turn the power on.**
- 2 Use INPUT   to switch to the input source from which you want to record.**

The selected input source appears on the display.

- 3 Recording starts.**
  - For information on operations, see the owner's manual of the recording device.



## ■ Contents

Setting the display's brightness	28
Setting the lighting LED brightness	29
Setting the Auto Standby mode	30
Setting remote control codes	31



## Setting the display's brightness



DIMMER

The display brightness can be adjusted between four levels. Switching the display off reduces a source of noise that affects sound quality, enabling higher sound quality playback.

### 1 Press DIMMER.

- The brightness of the display switches each time the button is pressed.



- If button operations are made while the display is off, information is temporarily displayed at the brightest setting.
- The display brightness is set to most brightly by default.
- DIMMER also works with Marantz Network SACD player SACD 30n (sold separately), so its brightness can be adjusted simultaneously when used in combination with this unit. If the devices have different brightness settings, press and hold DIMMER for 5 seconds or longer and adjust after they are both at the brightest setting.



## Setting the lighting LED brightness

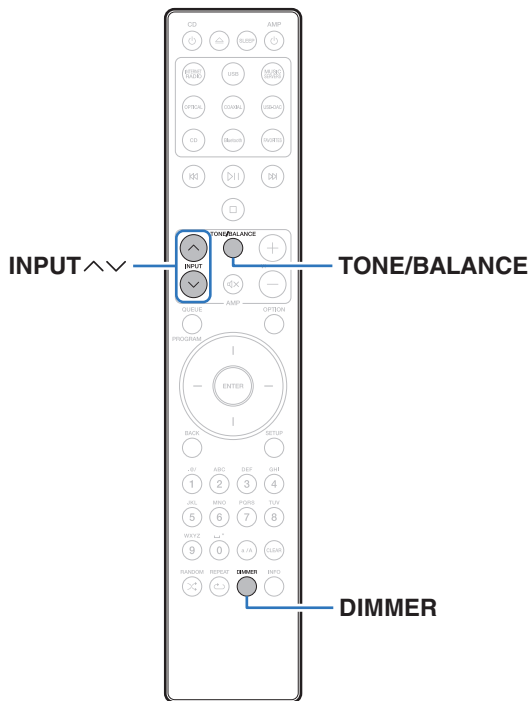

Lighting LED brightness can be adjusted in 4 levels. It can also be linked with the display's brightness. Switching the lighting off reduces a source of noise that affects sound quality, enabling higher sound quality playback.

- 1 Press and hold TONE/BALANCE for 5 seconds or more.**  
The lighting setting menu is displayed on the display.
- 2 Use INPUT ^ v to change to desired setting.**

<b>Sync</b> (Default):	The brightness is synchronized to the brightness of the display. (☞ p. 28)
---------------------------	--

<b>Bright / Dim / Dark / Off</b>
----------------------------------

- 3 Press TONE/BALANCE.**  
Setting is finalized and the display returns to usual status.



- If no operations are made for 5 seconds or more while setting lighting LED brightness or if other operations are performed, the setting is finalized and the display returns to usual status.
- When display brightness is set to off with DIMMER, the lighting LED turns off regardless of the lighting LED brightness setting. (☞ p. 28)



## Setting the Auto Standby mode

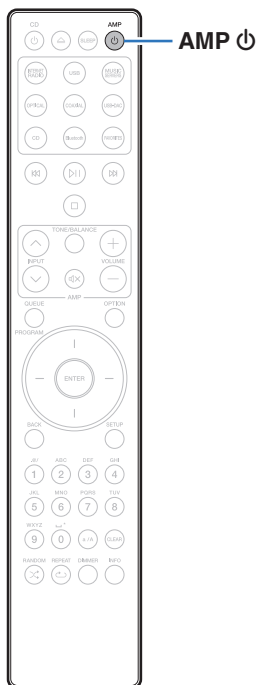

You can set the unit to automatically switch to standby mode if the unit is not operated for 30 minutes when there is no audio input (Auto Standby mode).

Auto Standby mode is set to off by default.

### 1 Press and hold AMP for 5 seconds or more to switch it on and off.

“Auto STBY On” or “Auto STBY Off” is displayed on the display.



## Setting remote control codes

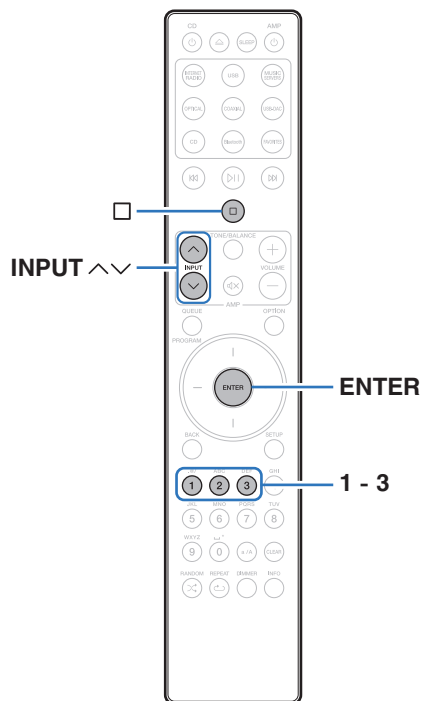

Remote control codes are set between this unit and the supplied remote control. You can select one of the three types of remote control codes, and the remote control can be used to control the unit when the same remote control code is used. If three of these units are used in the same location, all three units can be controlled simultaneously using one remote control in the default settings. By setting individual remote control codes between a unit and the remote control, the remote control can be used to control only the unit that has the same remote control code.

Be sure to check the operation of each unit after setting the remote control codes.

The default setting is “AMP1”.



- When remote control code setting is set to “AMP1”, the input source for this unit cannot be switched to “PWR AMP” using INPUT ^ v on the remote control. To switch with the remote control, change the remote control code setting to “AMP2” or “AMP3”.
- Set the remote control cord to “AMP 1” when controlling this unit from a Marantz network audio player or other device connected using a remote connection cable to this unit. (🔗 p. 20)



## Setting remote control codes for the remote control

### ■ To set the remote control codes to AMP1, AMP2 or AMP3

- 1 Hold down  $\square$  and one of the number 1, 2 or 3 buttons for more than 5 seconds.
  - Set the remote control code to AMP1, AMP2 or AMP3 according to the selected number button.

#### NOTE

- The remote control codes returns to the default settings when the batteries are removed. Set the remote control codes again after replacing the batteries.

## Setting remote control codes for the main unit

- 1 Point the remote control for which the remote control code was set at the main unit, and press  $\square$  and ENTER.  
When setting the remote control code of the main unit is complete, the remote control code set (AMP 1 – 3) is displayed on the display.





## ■ Contents

### Tips

I want to adjust the tone myself	34
I want to turn the display off	34
I want to turn the lighting LED off	34
I want to operate a Marantz Network SACD player using the remote control of this unit	34
I want to use this unit as a power amplifier	34
I want to use this unit as a pre-amplifier	34
I want to use more than one unit in one location	34

### Troubleshooting

Power does not turn on / Power is turned off	36
Operations cannot be performed through the remote control unit	37
Display on this unit shows nothing	37
No sound comes out	38
Desired sound does not come out	38
Sound is interrupted or noise occurs	39



# Tips

---

## I want to adjust the tone myself

- Use the BASS, TREBLE and BALANCE knobs to adjust the sound as desired. (👉 p. 24)

## I want to turn the display off

- Press the DIMMER button to turn the display off. (👉 p. 28)

## I want to turn the lighting LED off

- Change the “Lighting” setting to “Off”. (👉 p. 29)

## I want to operate a Marantz Network SACD player using the remote control of this unit

- Marantz Network SACD Players can also be operated with the remote control of this unit. Also refer to the Network SACD player's instruction manuals. (👉 p. 12)

## I want to use this unit as a power amplifier

- Connect a pre-amplifier to the POWER AMP IN connectors of this unit and switch the input source to “PWR AMP”. (👉 p. 19)

## I want to use this unit as a pre-amplifier

- Connect a power amplifier to the PRE OUT connectors of this unit. (👉 p. 19)

## I want to use more than one unit in one location

- Set individual remote control codes for each combination of devices and remote control. (👉 p. 31)



# Troubleshooting

---

If a problem should arise, first check the following:

1. **Are the connections correct?**
2. **Is the set being operated as described in the owner's manual?**
3. **Are the other devices operating properly?**

If this unit does not operate properly, check the corresponding symptoms in this section.

If the symptoms do not match any of those described here, consult your dealer as it could be due to a fault in this unit. In this case, disconnect the power immediately and contact the store where you purchased this unit.



## Power does not turn on / Power is turned off

### Power is not turned on.

- Check whether the power plug is correctly inserted into the power outlet. (🔍 p. 21)

### Power automatically turns off.

- The Auto Standby mode is on. When approx. 30 minutes pass with no audio input and no operations on the unit, this unit automatically enters the standby mode. To turn off the Auto Standby mode, press the AMP ⏻ button for 5 seconds or longer. (🔍 p. 30)
- When this unit and a Marantz audio device compatible with the power synchronization function are connected using a remote connection cable, the power of this unit turns off (standby) in synchronization with the power off operation of the device connected to this unit. (🔍 p. 20)

### The power turns off and the protection circuit indicator shows one long blink and two short blinks in orange.

- Stop playback on the playback device, and then turn the power off and on again.
- If the problem is not solved by turning the power off and on again, this unit's amplifier circuit has failed. Unplug the power cord and contact our customer service center.

### The power turns off and the protection circuit indicator shows one long blink and three short blinks in orange.

- This unit's power circuit has failed. Unplug the power cord and contact our customer service center.

### The power turns off and the protection circuit indicator shows one long blink and four short blinks in orange.

- The protection circuit has been activated due to a rise in temperature within this unit. Turn the power off, wait about an hour until this unit cools down sufficiently, and then turn the power on again.
- Please re-install this unit in a place having good ventilation.
- Check the speaker connections. The protection circuit may have been activated because speaker cable core wires came in contact with each other or a core wire was disconnected from the connector and came in contact with the rear panel of this unit. After unplugging the power cord, take corrective action such as firmly re-twisting the core wire or taking care of the connector, and then reconnect the wire. (🔍 p. 15)
- Stop playback on the playback device, and then turn the power off and on again.

### The power turns off and the protection circuit indicator shows one long blink and five short blinks in orange.

- Stop playback on the playback device, and then turn the power off and on again.
- If the problem is not solved by turning the power off and on again, this unit's amplifier circuit or power circuit has failed. Unplug the power cord and contact our customer service center.



## Operations cannot be performed through the remote control unit

### Operations cannot be performed through the remote control unit.

- Batteries are worn out. Replace with new batteries. (🔍 p. 5)
- Operate the remote control unit within a distance of about 23 ft/7 m from this unit and at an angle of within 30°. (🔍 p. 5)
- Remove any obstacle between this unit and the remote control unit.
- Insert the batteries in the proper direction, checking the ⊕ and ⊖ marks. (🔍 p. 5)
- The set's remote control sensor is exposed to strong light (direct sunlight, inverter type fluorescent bulb light, etc.). Move the set to a place in which the remote control sensor will not be exposed to strong light.
- When using a 3D video device, the remote control unit of this unit may not function due to effects of infrared communications between units (such as TV and glasses for 3D viewing). In this case, adjust the direction of units with the 3D communications function and their distance to ensure they do not affect operations from the remote control unit of this unit.
- The remote control code of the volume buttons on the remote control (VOLUME + - and 🔊) is set to the mode for operating a Marantz Network SACD player. If the volume of this unit cannot be adjusted using the remote control, press and hold ENTER and the number 1 button together for 5 seconds or more to change the remote control code to AMP operation mode.
- When the remote control code setting is set to "AMP1" (Default), the INPUT ^ v buttons on the remote control cannot be used to switch the input source to "PWR AMP" or switch from "PWR AMP" to another input source. To make remote control operations, change the remote control code setting to "AMP2" or "AMP3". (🔍 p. 31)
- The remote control code between this unit and the remote control is different. Set this unit and the remote control to the same remote control code. (🔍 p. 31)

## Display on this unit shows nothing

### Display is off.

- Press the DIMMER button, and change the setting to anything other than off. (🔍 p. 28)



## No sound comes out

### No sound comes out of speakers.

- Check the connections for all devices. (👉 p. 14)
- Insert connection cables all the way in.
- Check that input connectors and output connectors are not reversely connected.
- Check cables for damage.
- Check that speaker cables are properly connected. Check that cable core wires come in contact with the metal part on speaker terminals. (👉 p. 15)
- Securely tighten the speaker terminals. Check speaker terminals for looseness. (👉 p. 15)
- Check that the proper input source is selected. (👉 p. 24)
- The volume is set to the minimum level. Adjust the volume to a suitable level. (👉 p. 24)
- Cancel the muting mode. (👉 p. 24)

## Desired sound does not come out

### No sound comes out of a specific speaker.

- Check that speaker cables are properly connected. (👉 p. 15)
- Adjust the BALANCE control knob. (👉 p. 24)

### The left and right of stereo sound is reversed.

- Check whether the left and right speakers are connected to the correct speaker terminals. (👉 p. 16)



## Sound is interrupted or noise occurs

### When playing a record, the sound is distorted.

- Adjust to a proper needle pressure.
- Check the tip of the needle.
- Replace the cartridge.

### When playing a record, a humming noise comes out of the speakers.

- Check that the turntable is connected correctly. (👉 p. 17)
- If there is a TV or AV device near the turntable, such devices may affect the playback sound. Install the turntable in a location as far away as possible from the TV or other AV devices.

### When playing a record, a humming noise comes out of the speakers when the volume is high. (Howling phenomenon)

- Install the turntable and speakers as far from each other as possible. (👉 p. 17)
- The vibrations from the speakers are being transmitted to the player through the floor. Use cushions, etc., to absorb the speakers' vibrations.



## Explanation of terms

---

### MM/MC cartridge

There are two types--MM (Moving Magnet) and MC (Moving Coil)--of cartridges for turntable. As the output levels for these two types of cartridges differ, the setting of the phono equalizer that is mounted in this unit must be switched according to the type of cartridge for your turntable. The setting can be switched by the cartridge selector knob on the main unit. (☞ p. 8)

### Speaker impedance

This is an AC resistance value, indicated in  $\Omega$  (ohms). Greater power can be obtained when this value is smaller.

### Protection circuit

This is a function to prevent damage to devices within the power supply when an abnormality such as an overload, excess voltage occurs or over temperature for any reason.





## Specifications

- **RMS Power output (Simultaneous drive of both channels) :**
  - 100 W x 2 (8  $\Omega$ /ohms load, 1 kHz, T.H.D. 0.05 %)
  - 200 W x 2 (4  $\Omega$ /ohms load, 1 kHz, T.H.D. 0.1 %)
- **Total harmonic distortion**  
(1 kHz, simultaneous drive of both channels, 50 W, 8  $\Omega$ /ohms load) :
  - 0.005 %
- **Frequency response (CD, 1 W, 8  $\Omega$ /ohms load) :**
  - 5 Hz – 50 kHz  $\pm$ 3 dB
- **Damping factor (8  $\Omega$ /ohms load, 20 Hz – 20 kHz) :**
  - 500
- **Input sensitivity/Input impedance**
  - PHONO (MC Low) :** 250  $\mu$ V / 33  $\Omega$ /ohms
  - PHONO (MC Mid) :** 250  $\mu$ V / 100  $\Omega$ /ohms
  - PHONO (MC High) :** 250  $\mu$ V / 390  $\Omega$ /ohms
  - PHONO (MM) :** 2.3 mV / 39 k $\Omega$ /kohms
  - CD/TUNER/LINE/RECORDER :** 220 mV / 18 k $\Omega$ /kohms
  - POWER AMP :** 1.0 V / 18 k $\Omega$ /kohms
- **Output voltage/Output impedance**
  - PRE OUT :** 1.6 V / 220  $\Omega$ /ohms



- **Maximum allowable PHONO input level (1 kHz)**
  - MC Low/Mid/High: 8 mV
  - MM : 80 mV
- **RIAA deviation (20 Hz – 20 kHz) :** ±0.5 dB
- **S/N (IHF-A, 8 Ω/ohms load)**
  - PHONO (MC Low/Mid/High) : 75 dB (0.5 mV Input)
  - PHONO (MM) : 88 dB (5 mV Input)
  - CD/TUNER/LINE/RECORDER : 107 dB (Rated output)
- **Tone Control**
  - BASS (50 Hz) : ±10 dB
  - TREBLE (15 kHz) : ±10 dB
- **Operating temperature:** +5 °C - +35 °C
- **Power supply :** AC 120 V, 60 Hz
- **Power consumption :** 150 W
- **Power consumption in standby mode :** 0.2 W

For the purpose of improvement, the specifications and design are subject to change without notice.



## ■ Dimensions (Unit : in. (mm))

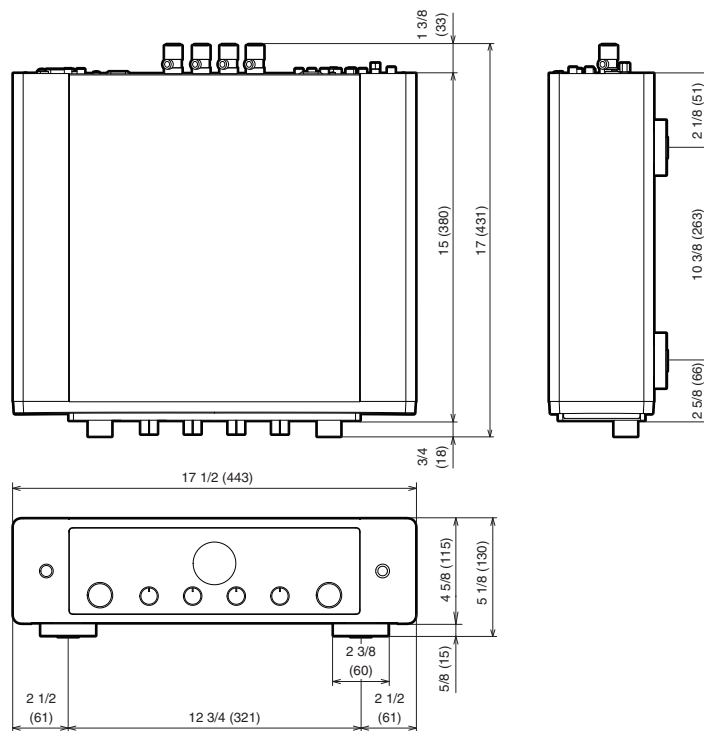

## ■ Weight : 32 lb 3 oz (14.6 kg)



# Index

<b>A</b>		
Auto Standby mode .....	30	
<b>B</b>		
Blu-ray Disc player .....	17	
<b>C</b>		
CD player .....	17, 25	
<b>F</b>		
Front panel .....	6	
<b>I</b>		
Input source .....	24	
<b>M</b>		
Muting .....	24	
<b>N</b>		
Network audio player .....	17	
<b>P</b>		
Power amplifier .....	19	
Pre-amplifier .....	19	
Protection circuit .....	40	
<b>R</b>		
Rear panel .....	9	
Recording device .....	18	
Remote control codes settings .....	32	
Remote control unit .....	11	
<b>S</b>		
Speaker impedance .....	40	
Speakers .....	15	
<b>T</b>		
Tips .....	34	
Tone .....	24	
Troubleshooting .....	35	
Tuner .....	17	
Turntable .....	17	
<b>V</b>		
Volume .....	24	



**[www.marantz.com](http://www.marantz.com)**

You can find your nearest authorized distributor or dealer on our website.

**marantz**<sup>®</sup> is a registered trademark.

3520 10770 00AMA

© 2020 Sound United. All Rights Reserved.