

kinetik

UST Projector AV Cabinet  
KLIF-UST1CS





# CONTENTS

01

DESIGN DESCRIPTION

02

DESIGN FEATURES  
& VISUALS

03

TECHNICAL  
DRAWINGS

04

SPECIFICATIONS





Image: Kinetik KLIF-UST1CS(BLK) UST Centre and Sides Soft Black

## DESIGN DESCRIPTION

---

This cabinet has been designed to accommodate UST (Ultra Short Throw) projectors. The dimensions of the unit allow the chosen screen to be positioned at a height which ensures comfortable viewing when seated. It has been designed to accommodate both 120" and 100" screens. The centre of the screen (for the 120" projector) is 1442mm from the floor, and the minimum ceiling height is 2209mm.

The back panels are in an engineered 'through core colour' material ensuring that cable access routes and ventilation cut outs do not expose an unfinished core of a different colour, as would be the case with laminated or painted MDF or MFC.

The opening below the projector has a central recessed support panel, allowing space for a centre speaker if desired.

The main projector cabinet can be stand-alone or coupled with one or more complimentary side units in the same material and height. The side units are 550mm wide and have rear ventilation and cable access, games consoles and AV equipment.

Standard finishes are dark grey (soft black), a matte white (alpine white) and the premium finish is timber material (Graphite Denver Oak) and options are given to have contrasting doors. Additional finishes are available upon request across a variety of textures including wood, stone and metal effects.



## DESIGN FEATURES

---

- The centre unit has been designed to accommodate a wide range of UST
- The sound bar shelf of the centre unit is removable for projectors that are designed to be closer to the wall
- All units are manufactured in a non-reflective matte finish using 18mm Egger material
- All units have individually adjustable legs for levelling
- Flat Packed for easy transport and handling
- Easy on-site assembly
- Side cabinets are designed to accommodate a wide range of AV and gaming equipment
- Adjustable shelves in the side units
- 10mm front ventilation gap in the side units
- Pre-engineered back panels incorporating ventilation and cable management
- Onyx soft close hinges & shelf pins
- Invisible cabinetry fixings

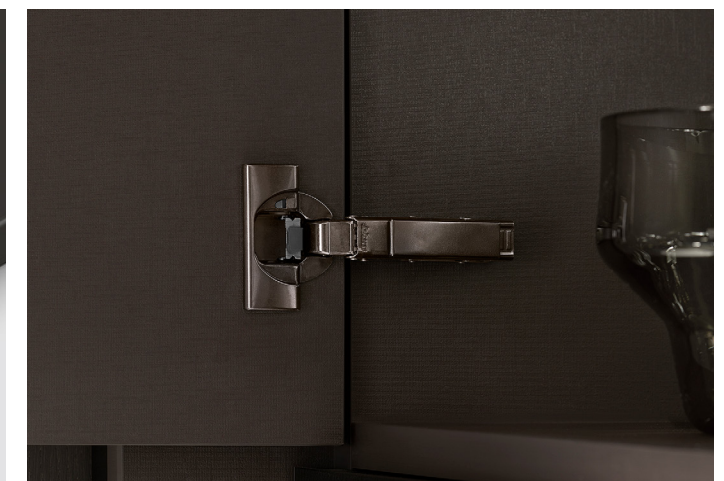
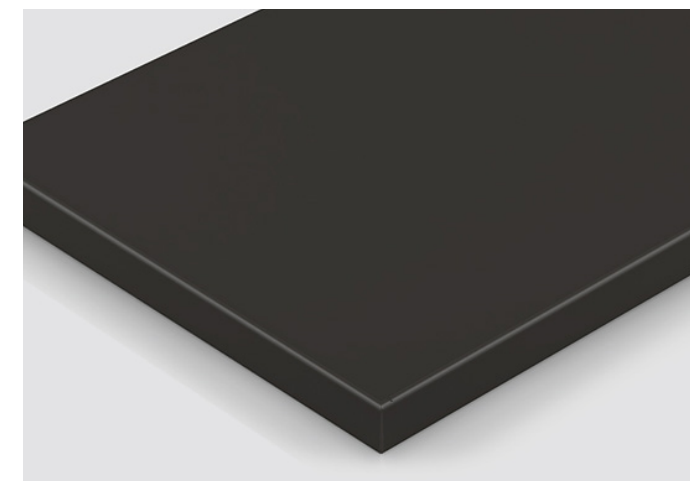
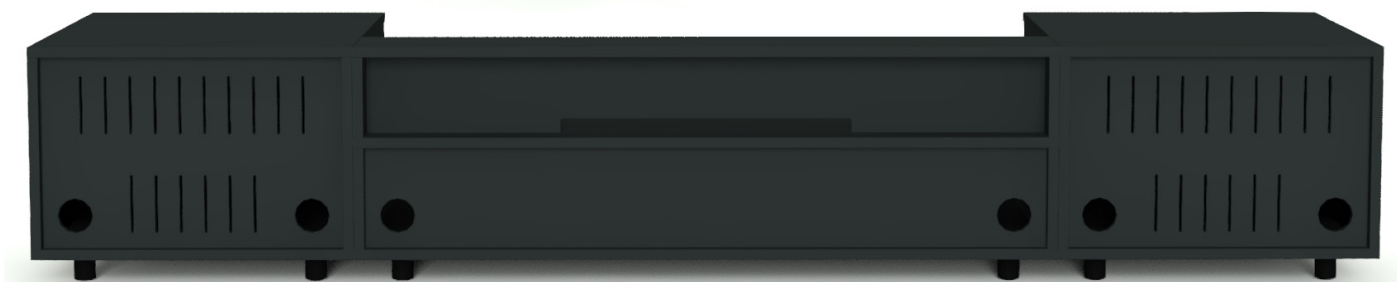
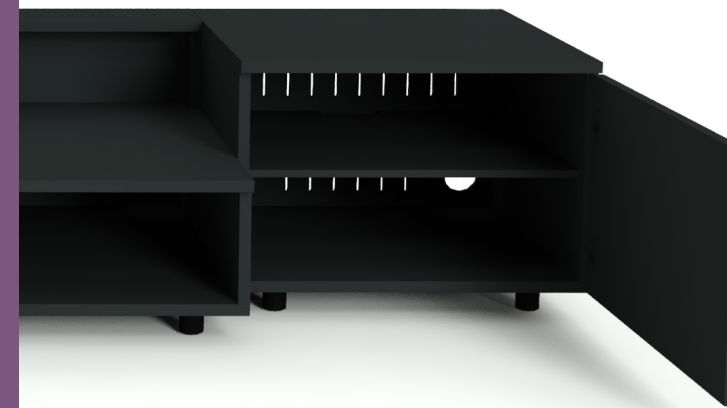



## COLOUR OPTIONS

---

- Standard colour options
  - Soft Black
  - Alpine White
- Premium colour option
  - Graphite Denver Oak



Image: Kinetik KLIF-UST1CS(BLK) UST Centre and Sides Soft Black

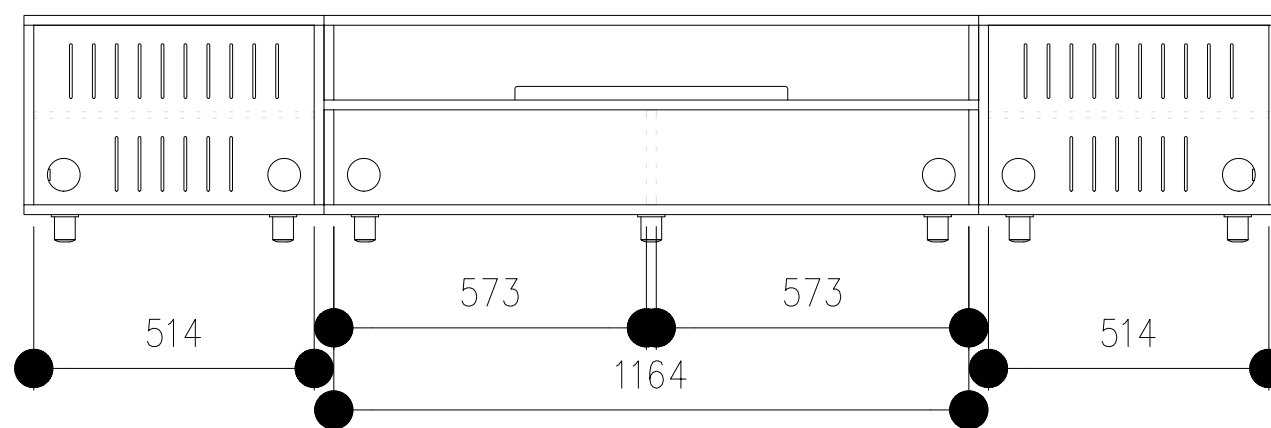
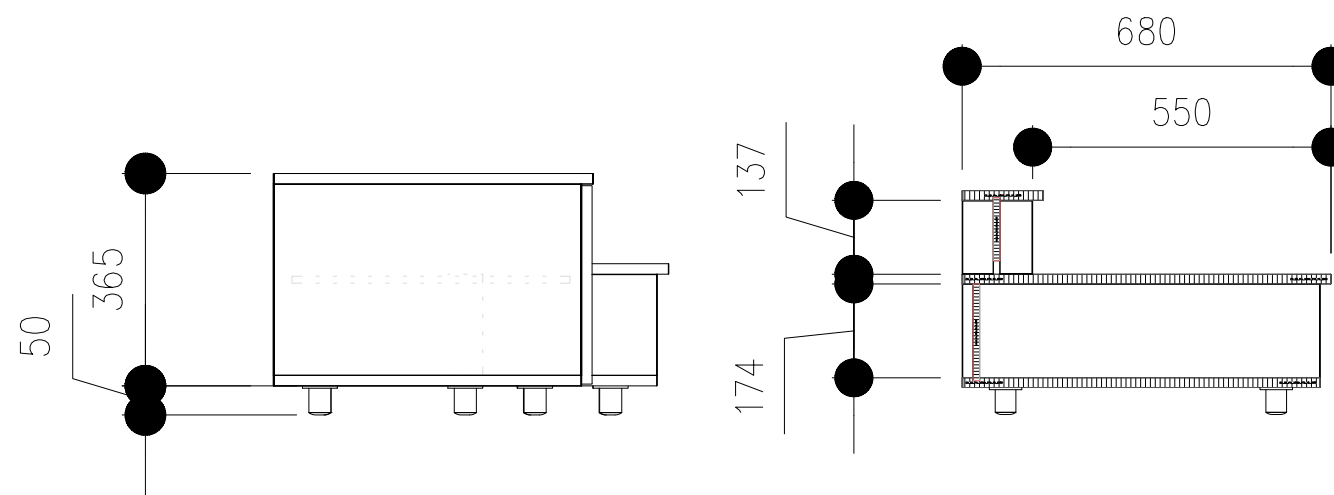
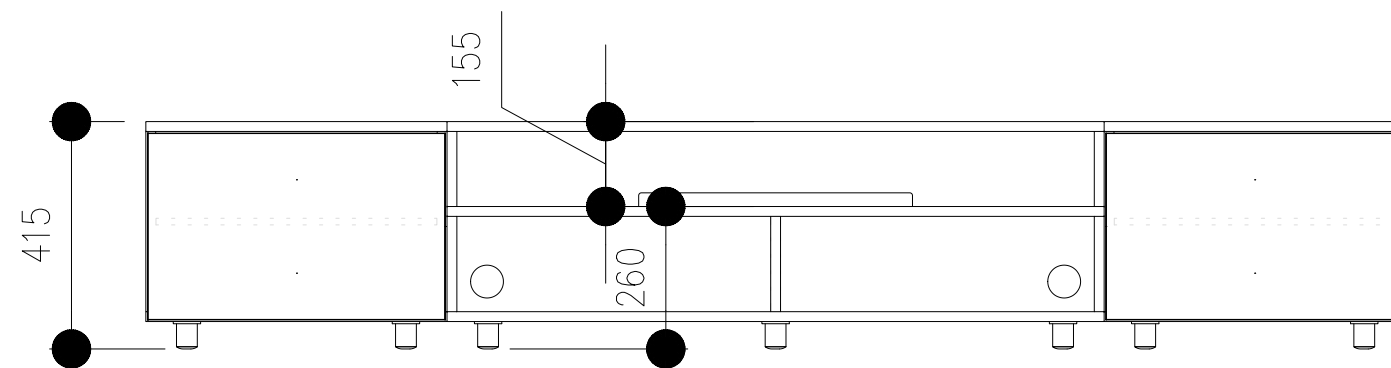
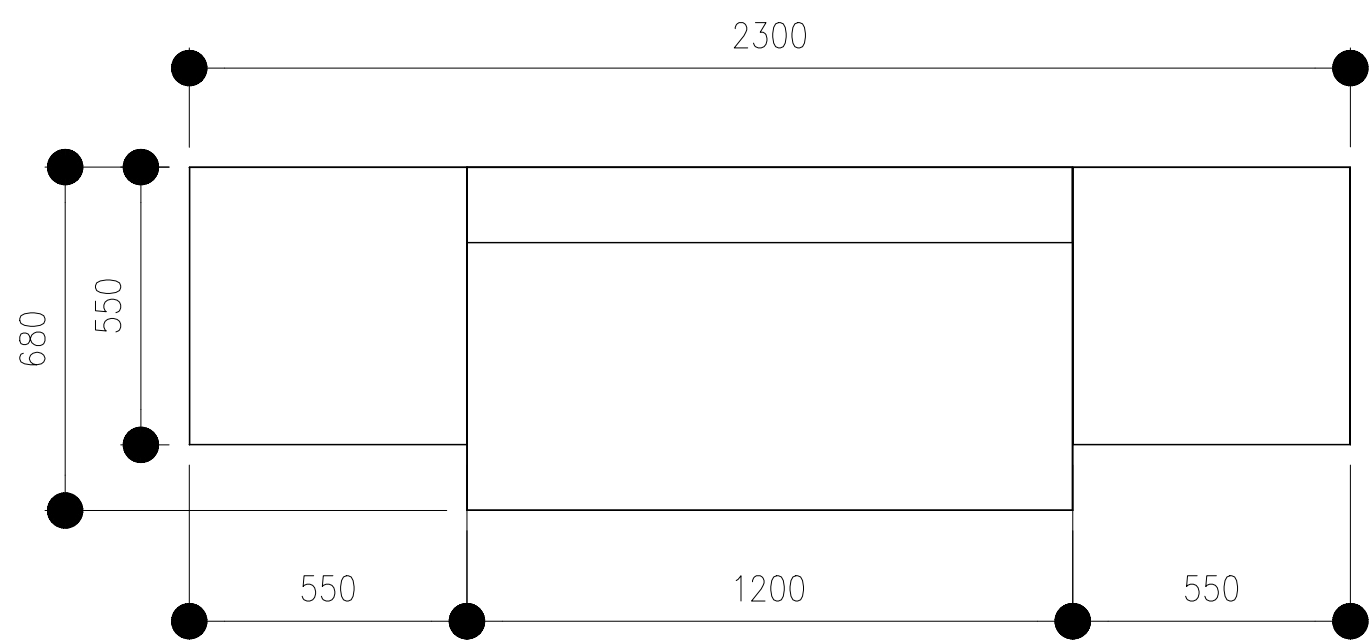

Image: Kinetik KLIF-UST1CS(WHT) UST Centre and Sides Alpine White



Image: Kinetik KLIF-UST1CS(GDO) UST Centre and Sides Graphite Denver Oak







**KLIF-UST1CS CABINET**

**Specification:**

	Projector cabinet unit	Side cabinet units (each)
Weight kg	29	23
No. of panels	10	7
Maximum panel size	1200 x 700	720 x 550
Dimensions with feet (H W D)	405 x 1200 x 700	405 x 550 x 700
Packing dimensions	1200 x 700 x 72	1100 x 550 x 72
Floor – bottom of screen*	675mm	
Floor – middle of screen*	1442mm	
Floor – top of screen*	2209mm	

\* It has been designed to accommodate both 120" and 100" screens.

**Kinetik Labs is distributed by:**

**AWE Europe LTD**

Alexander House  
3A Blenheim Road  
Epsom  
Surrey  
KT19 9AP  
United Kingdom

**Phone**

+44 (0)1372 729 777

[www.awe-europe.com](http://www.awe-europe.com)