

Area		JAPAN	NORTH AMERICA	EUROPE	GENERAL AREA	CHINA
Model Name		FW-85BZ30L	FW-85BZ30L	FW-85BZ30L	FW-85BZ30L	FW-85BZ30L
SV No.		SV-41551	SV-41401	SV-41481	SV-41482	SV-41509
DIMENSION	TV only (W x H x D)	189.9 x 108.9 x 7.1 cm	1899 x 1089 x 71 mm / 74 7/8 x 42 7/8 x 2 7/8 inch	Approx. 189.9 x 108.9 x 7.1 cm	Approx. 1899 x 1089 x 71 mm	Approx. 1899 x 1089 x 71 mm
	TV only with camera (W x H x D)	-	-	-	-	-
	TV with Stand (Standard position) (W x H x D)	189.9 x 117.6 x 45.6 cm	1899 x 1176 x 456 mm / 74 7/8 x 46 3/8 x 18 inch	Approx. 189.9 x 117.6 x 45.6 cm	Approx. 1899 x 1176 x 456 mm	Approx. 1899 x 1176 x 456 mm
	TV with Stand (Narrow position) (W x H x D)	-	-	-	-	-
	TV with Stand (Soundbar position) (W x H x D)	-	-	-	-	-
	TV with Stand (Front position style) (W x H x D)	-	-	-	-	-
	TV with Stand (Back position style) (W x H x D)	-	-	-	-	-
	TV with Floor Stand (W x H x D)	-	-	-	-	-
	Stand Width (Standard position)	153.2 cm	1532 mm / 60 3/8 inch	Approx. 153.2 cm	Approx. 1532 mm	Approx. 1532 mm
	Stand Width (Narrow position)	-	-	-	-	-
	Stand Width (Soundbar position)	-	-	-	-	-
	Stand Width (Front position style)	-	-	-	-	-
	Stand Width (Back position style)	-	-	-	-	-
	Floor Stand Width	-	-	-	-	-
WEIGHT	VESA Hole Pitch	40.0 x 40.0 cm	400 x 400 mm / 15 3/4 x 15 3/4 inch	40.0 x 40.0 cm	400 x 400 mm	400 x 400 mm
	TV Only	44.5 kg	44.5 kg / 98.1 lb	Approx. 44.5 kg	Approx. 44.5 kg	Approx. 44.5 kg
	TV with Stand (Standard position)	46 kg	46 kg / 101.4 lb	Approx. 46 kg	Approx. 46 kg	Approx. 46 kg
	TV with Stand (Narrow position)	-	-	-	-	-
	TV with Stand (Soundbar position)	-	-	-	-	-
	TV with Stand (Front/Back position style)	-	-	-	-	-
	TV with Floor Stand	-	-	-	-	-
	Floor Stand weight (Supply)	-	-	-	-	-
Remarks			Optional stand	Optional stand		

WITH STAND

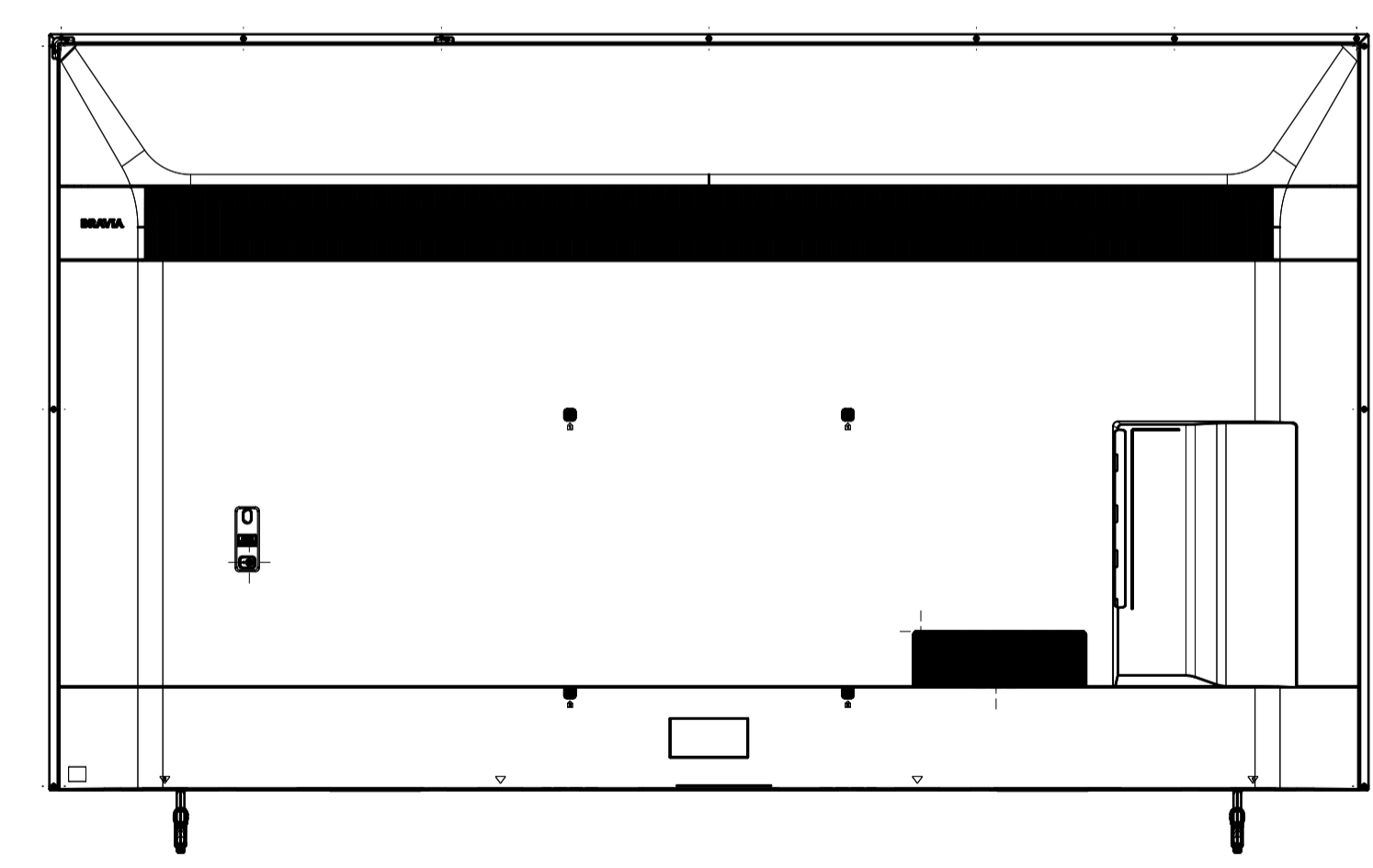
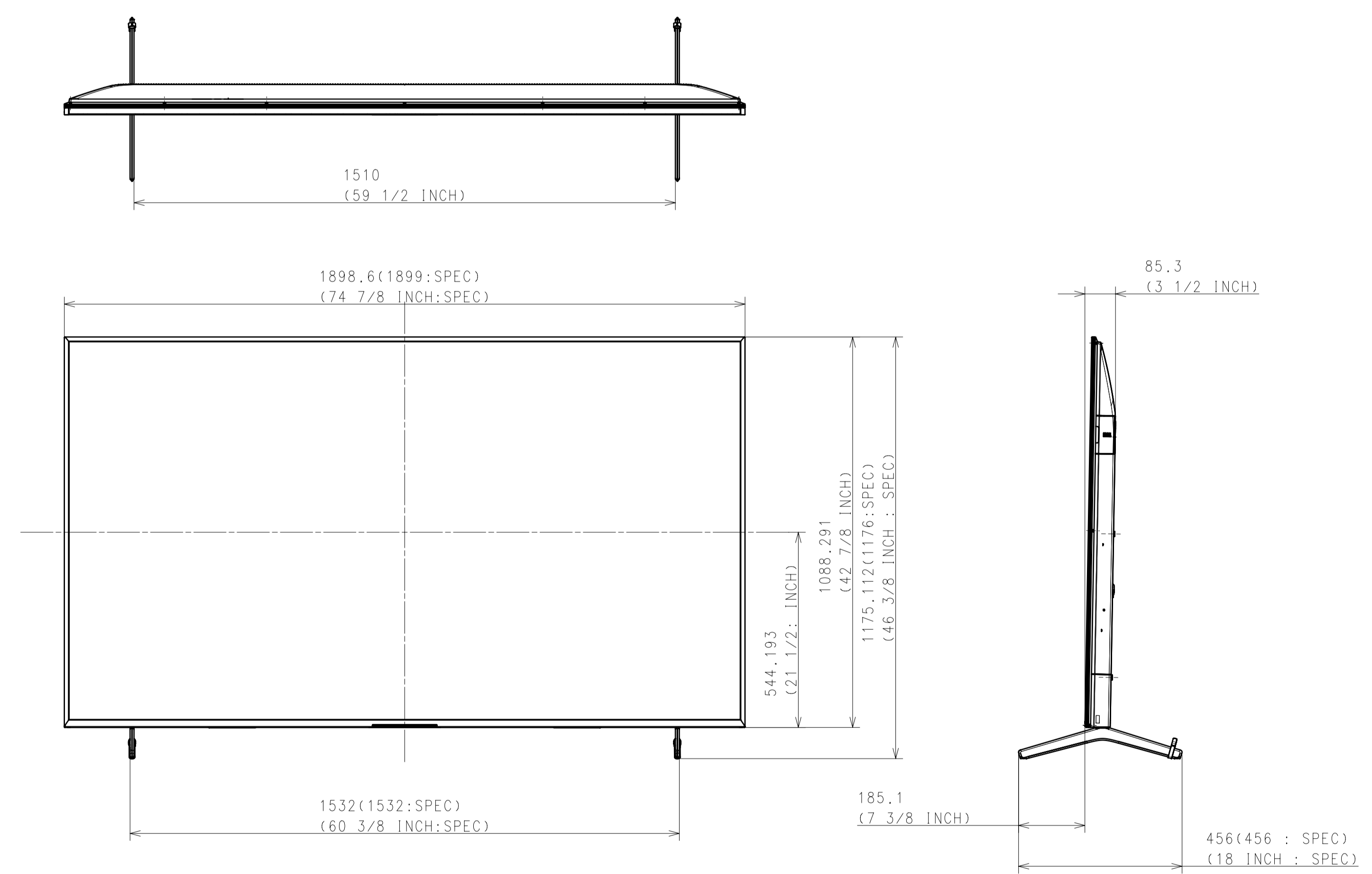

Purchase recycled resins and wire rods only from the business partners that Sony approves as Green Partners.

DATE OF ISSUE 2023.01.09		DOCUMENT TYPE ASSEMBLY		GENERAL TOLERANCE		TOLERANCING DRAWING (JIS & ISO/IEC 8015)	
MATERIAL COLOR		FINISH COLOR		SIGN.			
RESPONSIBLE DEPARTMENT PANEL & MECHANICAL DESIGN				ORIGINAL MODEL		DESCRIPTION 85(BZ30L) EXTERIOR VIEW	
DRAWN BY		CHECKED BY		APPROVED BY		SCALE 1:10	
TENTATIVE MODEL		SIZE A1		UNIT mm		SHEET/PAGES 1/3	

WITHOUT STAND

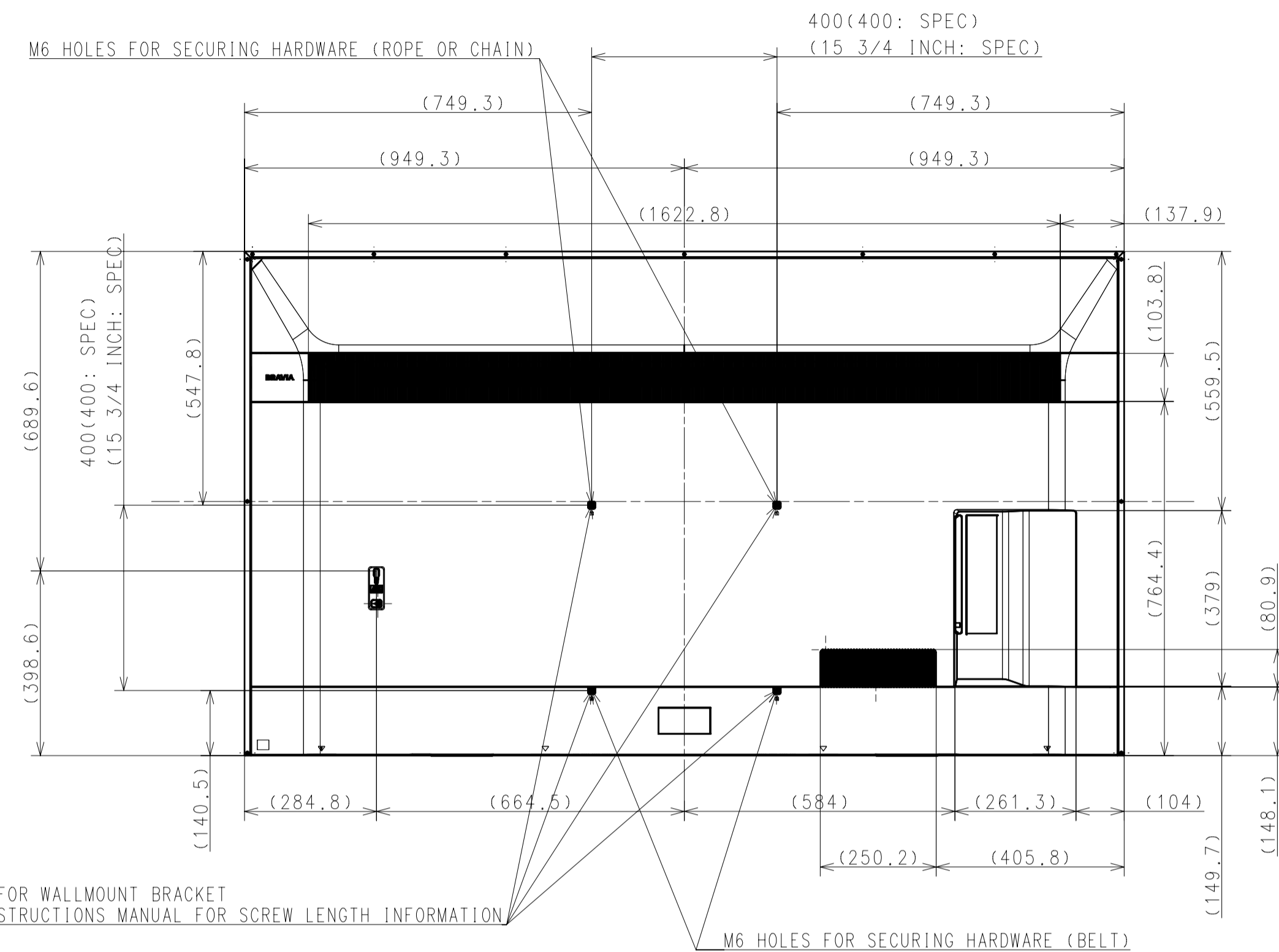
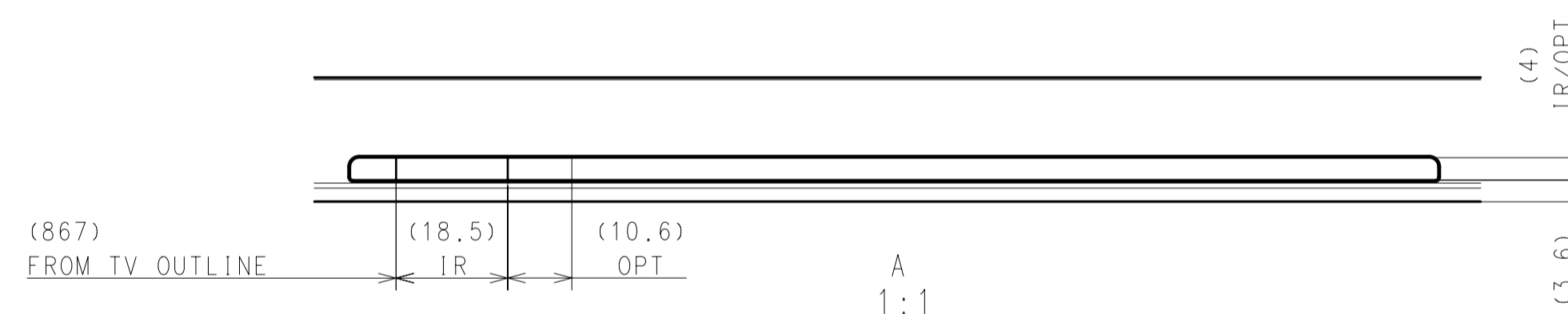
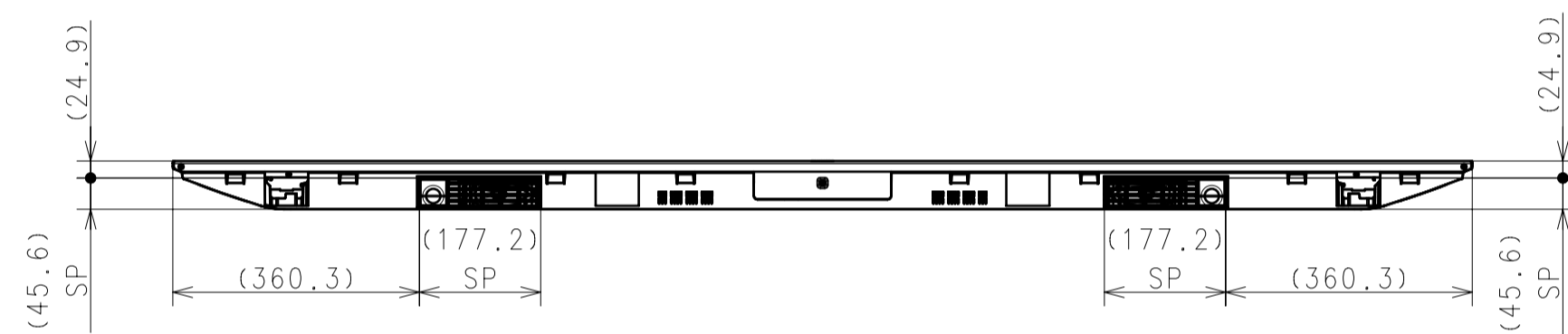
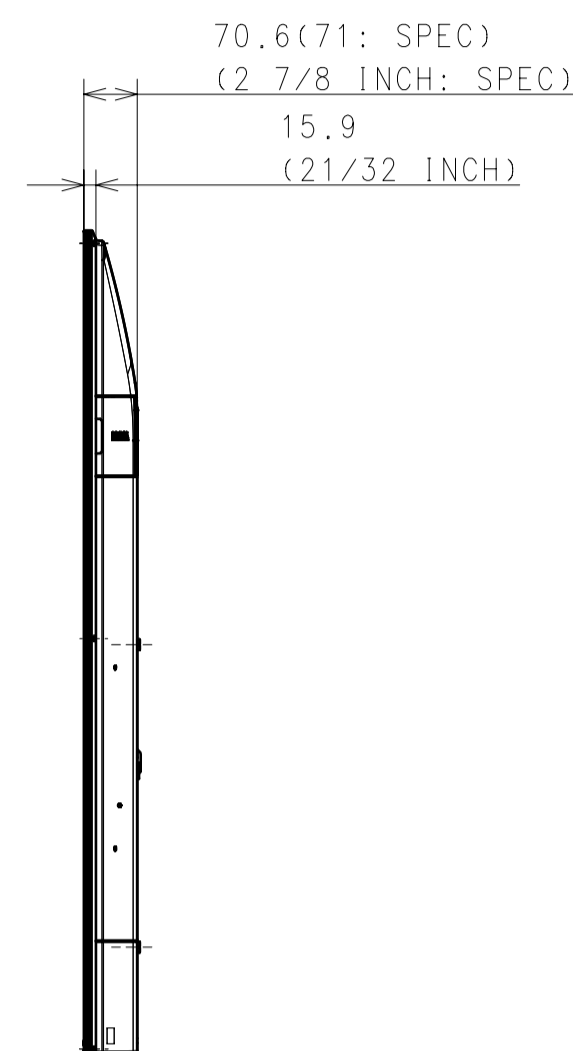
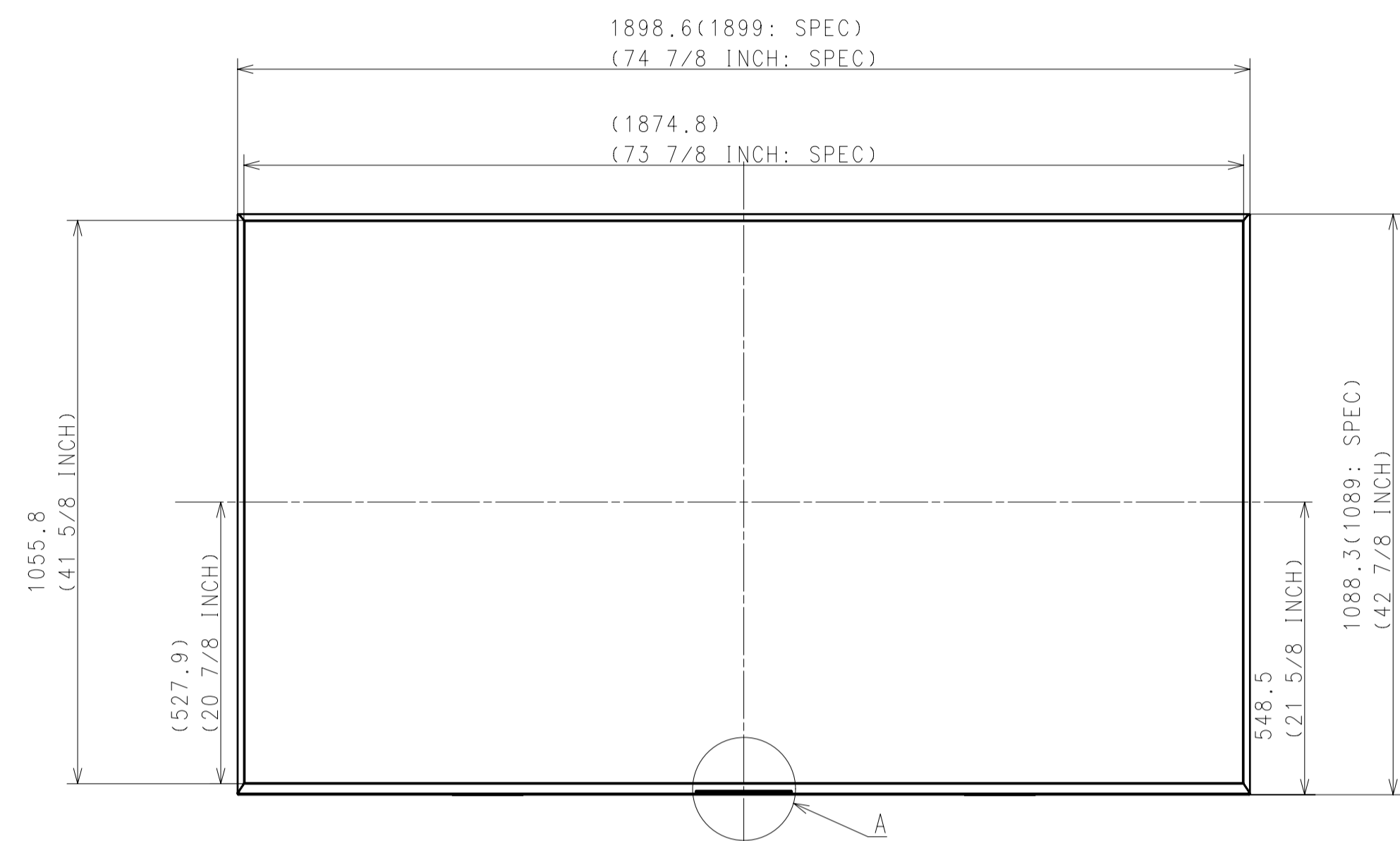

For NORTH AMERICA, EUROPE, GENERAL AREA, CHINA

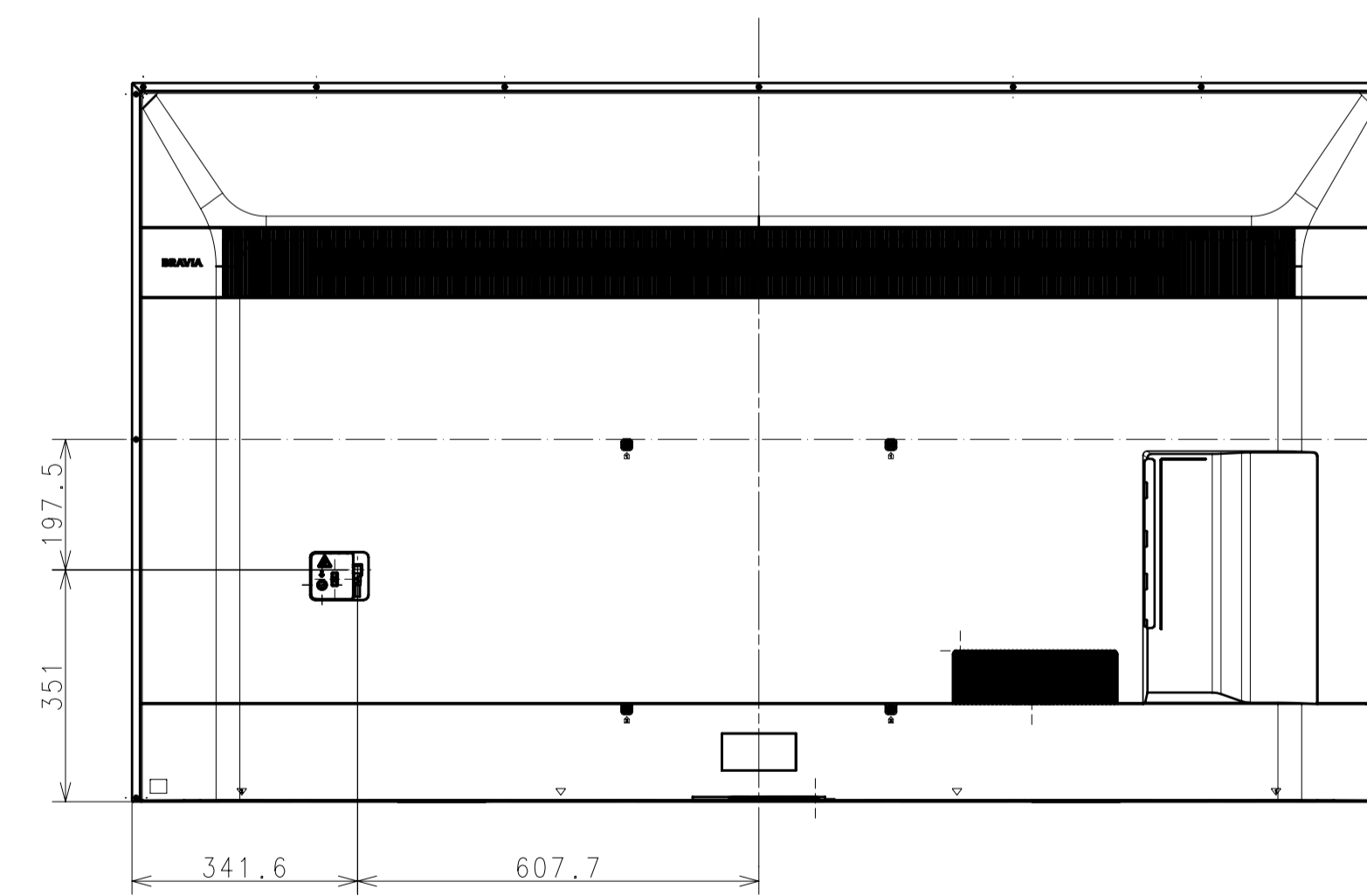

For JAPAN

DESCRIPTION 1	LEGAL OWNER	SCALE
85(BZ30L) EXTERIOR VIEW	Sony Corporation	1:1
DESCRIPTION 2	PART NO.	SHEET/PAGES
85(BZ30L) EXTERIOR VIEW		2 / 3

SU\_WL450 SLIM

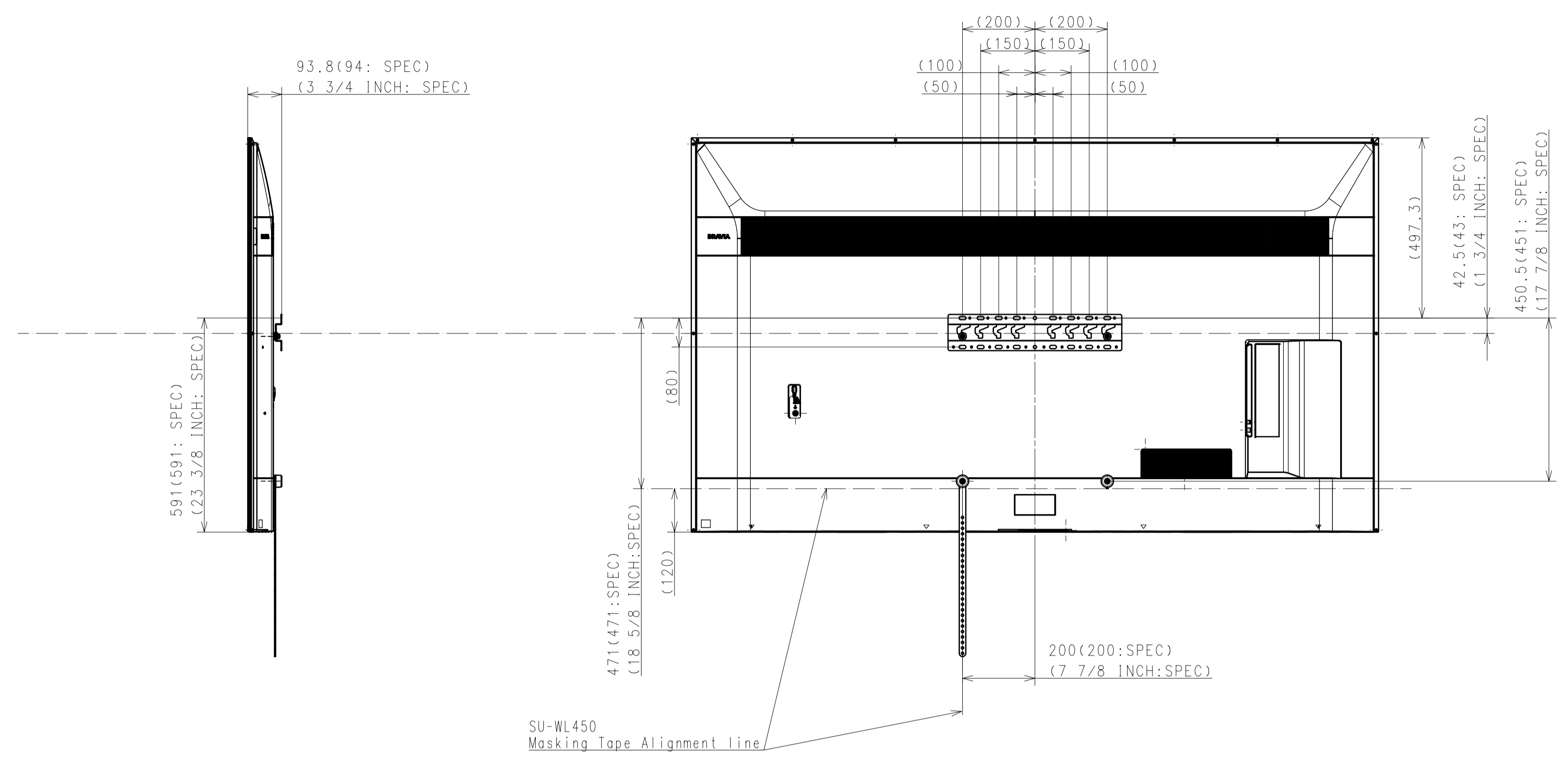

SU\_WL450 STANDARD

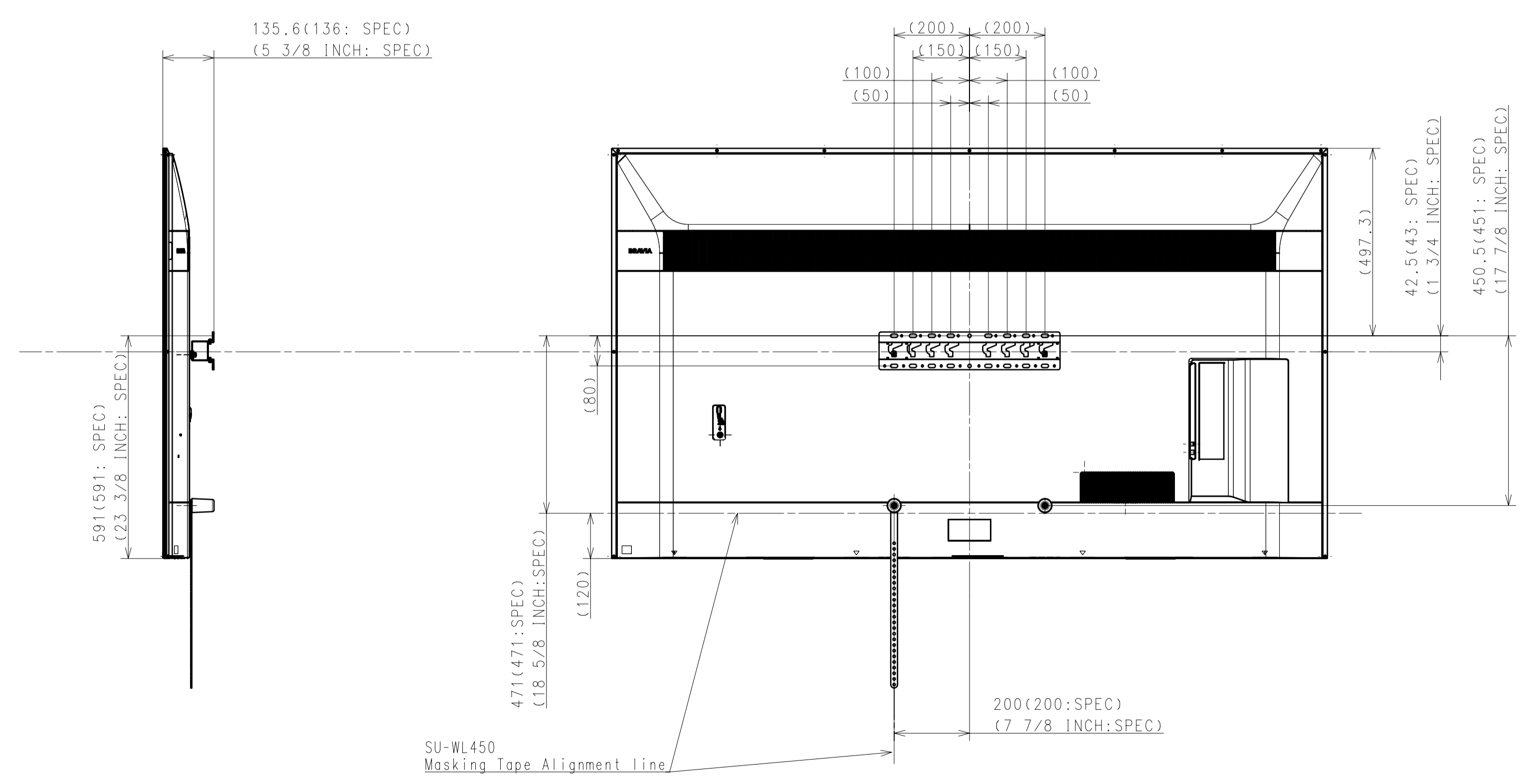

DESCRIPTION	LEGAL OWNER	SCALE
85(BZ30L) EXTERIOR VIEW	Sony Corporation	1:1
85(BZ30L) EXTERIOR VIEW	PART NO.	SHEET/PAGES
		3 / 3