

CDA-16

Installation Instructions

Bowers & Wilkins



1 x

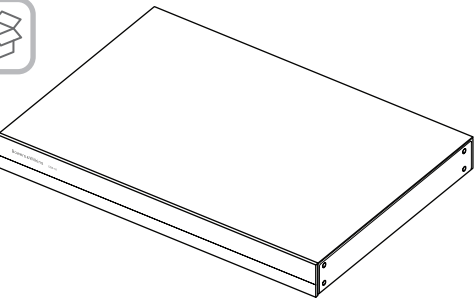

2 x

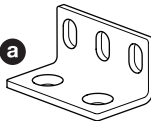

4 x

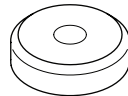

1 x



4 x



4 x



8 x

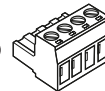

1 a

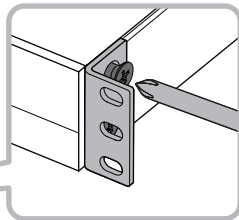
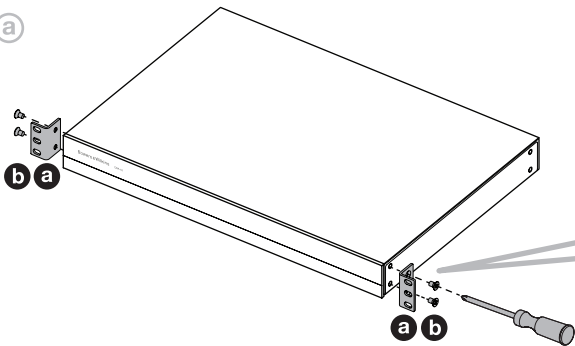

≥ 50mm (2in)

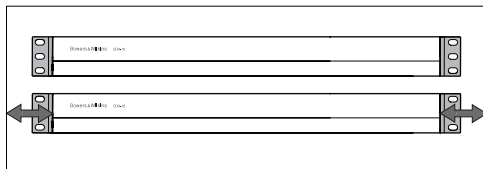

≥ 50mm (2in)

1b

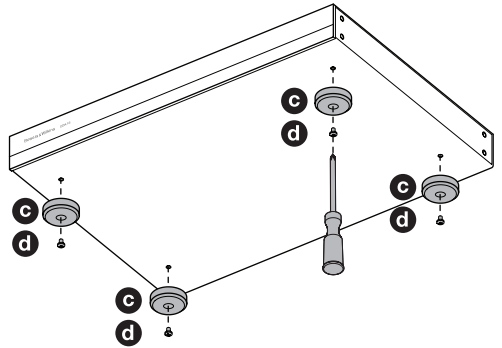

2

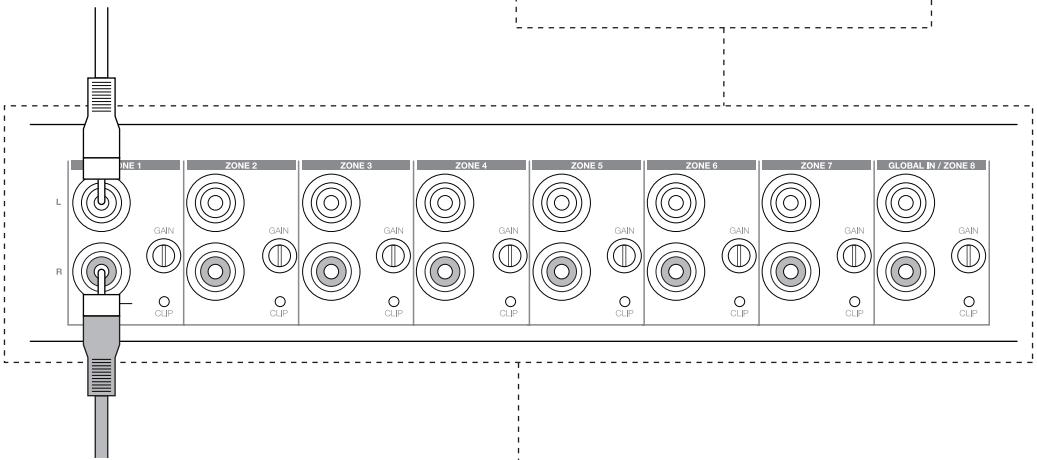
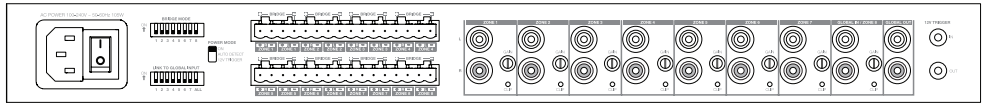

RCA

3

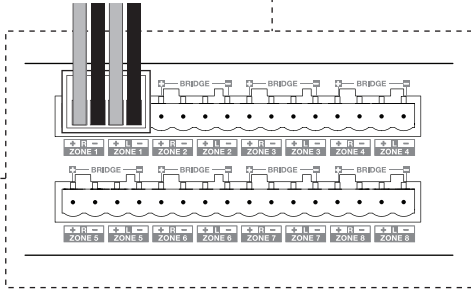
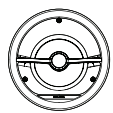
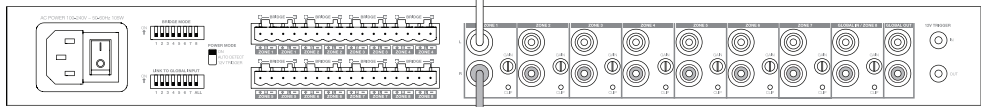

e

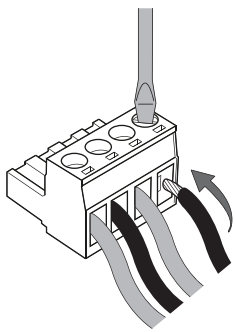

4

