

High-High-End.
Loewe Reference ID.

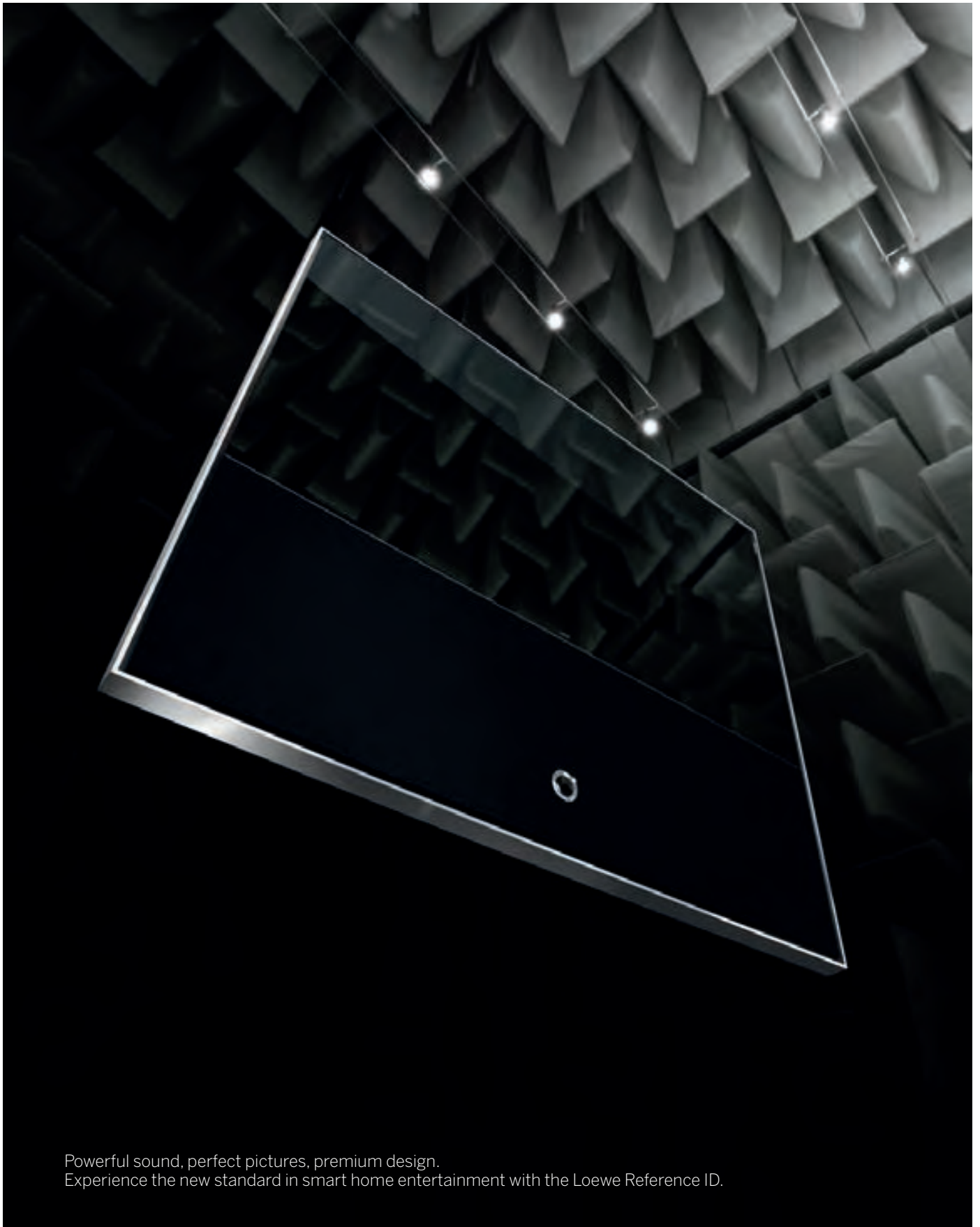

LOEWE.



Powerful sound, perfect pictures, premium design.
Experience the new standard in smart home entertainment with the Loewe Reference ID.

Perfection
for all senses.
Loewe Reference ID.

Symphony.

Discover the most exclusive
sound-picture combination
in the world.



Find out more about the perfect union of image, sound and design >

Brilliant sound.

Integrated 2.1 sound: The two integrated broadband speakers and 6" subwoofer produce fantastic music power of 160 watts. A frequency range from 50 Hz to 20,000 Hz and a speaker volume of 5.5 litres are just two of the secrets behind the Loewe Reference ID's impressively rich, room-filling sound.



Ceramic speaker: The Loewe Reference ID speakers, supplied separately, further expand the already extensive sound spectrum. Made from extremely torsion-resistant ceramic, the tweeters guarantee up to 40,000 Hz of dynamic, crystal-clear sound. The D'Appolito configuration of the total of six speakers creates an exceptionally fine and transparent sound pattern. Together with a Loewe Subwoofer 800, the Loewe Reference ID speakers are the ideal solution for your personal smart home entertainment system.



Perfect sound processing: The purely digital audio signal path (see illustration), with very high 32-bit resolution and sophisticated, puristic sound processing, guarantees undistorted sound – even for challenging musical compositions with high dynamics. Thanks to the integrated 5.1 decoder and digital audio system interface (DAL), the Loewe Reference ID is also optimally equipped to deliver perfect home cinema sound without any additional external AV receiver.

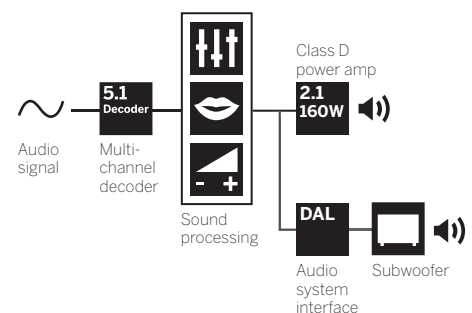



Brought together in a top-quality design.

Precisely crafted: The Loewe Reference ID is perfect in every respect – no matter what side you look at it from. Timeless, minimalist lines, fine, precise workmanship and haptic quality make the Loewe Reference ID a high-end product in terms of design too. As demonstrated by its polished aluminium frame and attractive black, titan, white or silver rear panel. The small size of the gaps is thanks to the precision of Loewe's manufacturing processes.

The Piezo buttons on the top of the frame allow you to control all the main functions: switch on and off, adjust the volume, change channel and operate the LED backlighting around the television set.



Brilliant image quality.

Grey glass contrast filter panel: The television panel is finished with a premium contrast filter panel with real anti-reflection glass on both sides – produced by one of the best known German glass companies. This filter panel makes the picture visibly more precise, optimising contrasts and reducing reflections by a factor of around 10. The glass also protects the sensitive TV panel.



Impressive depth with 3D active shutter: The high brightness and repetition rate of the Loewe Reference ID pave the way for vivid 3D representation with smooth, flowing movements – even in light rooms. The Loewe Reference ID also has a converter to allow you to enjoy even 2D content in 3D, almost real enough to touch.



Crystal-clear images: The Loewe Reference ID allows you to experience 200 frames per second – together with intelligent control of the LED backlight, this creates a convincing 400-Hz image impression. Finally, additional intelligent algorithms ensure the perfect depiction of extremely fast movements.





Meticulous.

Perfection is not a miracle –
it is a result.



Made in
Germany
since 1923

For more than 90 years, Loewe has been setting the standard for smart home entertainment time and time again. The foundation of this top quality is without doubt the “Made in Germany” label: All the main production steps take place at Loewe in Germany – from the first design draft to development, assembly and final quality inspection. The scientific cooperation with the test laboratory of the Fraunhofer Institute for Digital Media Technology IDMT illustrates the exacting standards. For example, the test laboratory carried out detailed measurements of the acoustic properties of the Loewe Reference ID.

The findings of the Fraunhofer Institute for Digital Media Technology IDMT speak for themselves – and for the Loewe Reference ID: great acoustic pressure, finely tuned sound pattern and deep, powerful low tones. In the tests, the audio signal was reproduced practically unaltered across the entire spectrum from 50 Hz to 20,000 Hz. No non-linear distortions of more than 5% occurred, even at a maximum noise level of 102 dB. Thanks to a high maximum noise pressure level of up to 102 dB, the Loewe Reference ID effortlessly fills even large rooms with impressive sound.

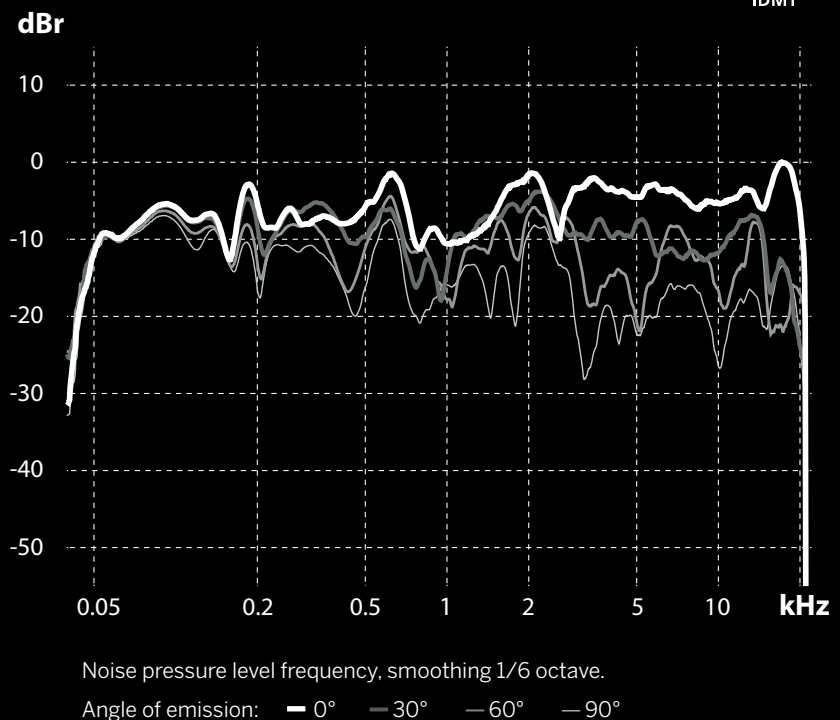

The frequency range of the Loewe Reference ID is balanced across the entire playback spectrum: An essential requirement for authentic sound.



LOEWE

Haute Couture.

Enhance your home
with the most beautiful materials.

What dreams are made of: The front cover of the speakers is large enough to allow you to add an exquisite touch to your interior with a selection of premium materials: from plain black, white or titan to eye-catching fabric designs with black, beige or gold diamond patterns – the choice is yours when it comes to the design and desired effect for your television.





Finesse.

The fine art of the frame.

The frame adds the perfect finishing touch to any painting.

Vincent van Gogh viewed the frame as a sign of respect and appreciation for a work of art. One of the distinguishing features of the Loewe Reference ID is the fact that you can also choose your own precisely crafted frame. From Aluminium Silver to Aluminium Black, Aluminium Titan and High Gloss White: Choose the finishing touch for your work of art.

Presence.

Show your true
stature.

A powerful but unobtrusive

presence: Thanks to its minimalist design, the Loewe Reference ID brings you perfect smart home entertainment that blends seamlessly into your personal living environment, in a choice of 40, 46 or 55 inch screen sizes. What's more, its 360° design turns the Loewe Reference ID into an artistic sculpture that you can position wherever you wish in your room.

LOEWE





Ideal to lean your TV against a wall:
Loewe Floor Wall Mount.

Charisma. Showcase your entertainment.

Every interior requires a customised solution:

Offering a myriad of choice, the Loewe Reference ID helps you to find the perfect solution to showcase your television in your home. Lean your TV casually against the wall or use the Loewe Floor Stand to turn it into a striking feature – the choice is yours.





A stylish statement:
Loewe Floor Stand – motorised
rotation mechanism.

Free-standing option for any room:
Loewe Floor Stand Dynamic.

Aura.

Show your favourite object
in its best light.

You can, of course, choose to mount your Loewe Reference ID on a wall. This spectacular positioning turns your television into an amazing work of art. The optional integrated LED backlighting gives the Loewe Reference ID an elegant aura, highlighting your key priority: top-quality smart home entertainment.





Momentum.

Conquer time and space.





Loewe's DR+ technology makes TV viewing even more convenient: numerous functions allow you to enjoy your entertainment wherever you happen to be.



Loewe DR+ Streaming is a very convenient function that is ideal for anyone who has more than one Loewe television. A network connection (LAN/WLAN/Powerline¹) gives you easy access to all the films stored in your DR+ archive. **What's more, the Follow-Me feature²** allows you to continue watching a live television programme on a second TV set.



The integrated 1,000 GB hard drive (around 450 hours in HD) ensures that your film collection is always within easy reach on your Loewe Reference ID. Recording a film is just as easy as pausing or resuming a television programme: simply press a button on your remote control. You can even record a programme while watching something else, thanks to Dual Channel.

¹ Powerline available separately from Loewe specialist dealers.

² The Follow-Me function will be available via Loewe MediaUpdate.

Maestro.

Conduct your entertainment:
quickly, conveniently and elegantly.

A small movement is all it takes to smoothly glide the cursor over the screen and select a TV channel, photo file or news app. The intelligently structured Loewe Assist Media user interface makes operating the extensive range of media features child's play. Clear icons and sophisticated animations also pave the way for intuitive user navigation.



Up, down, left, right. OK. That's all it takes to effortlessly and precisely control a whole universe of media content. This simple cross navigation concept applies across all levels and areas of Loewe Assist Media.



Home screen with your Favourites: from television channels to photo albums, multimedia libraries and Internet apps: simply press the star key to store your favourites directly on the home screen. It couldn't be easier or more personalised.



One remote control for everything. The high-quality Loewe Assist remote control operates your television and source devices, such as a Blu-ray player or set-top boxes. It can also be used to control the SoundBox, SoundVision and many other Loewe products.



Award-winning operating pleasure. The Loewe Assist Media app for iPads and iPhones allows you to elegantly operate the complete TV menu at the touch of a finger.





Forum.

Enjoy unlimited entertainment.

Latest news: Special apps in Loewe MediaNet from news providers such as ITN, BBC News and Euronews keep you up to date with all the main events around the clock. Not forgetting in the UK the red button text service on BBC channels.



“Hinkebein” picture: WDR/Martin Menke

Video and catch up services: Depending on your country various catch up services are available, for example in the UK you can catch up on services from the BBC using the BBC iPlayer. Other video services include Loewe’s own “Videonet”.

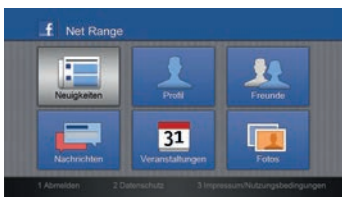

Want to keep in touch with your friends? With the Facebook app, you can access and comment on their posts, update your own status, etc. at any time. In large format and straight from your living room.

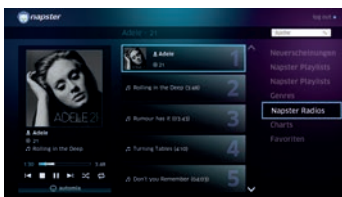

As much music as you want: Music streaming services such as Audeo! offer you huge databases of new and classic music. The Q-tom portal even allows you to enjoy music videos from many niche channels. Not forgetting a selection of more than 8,000 Internet radio stations from all over the world.

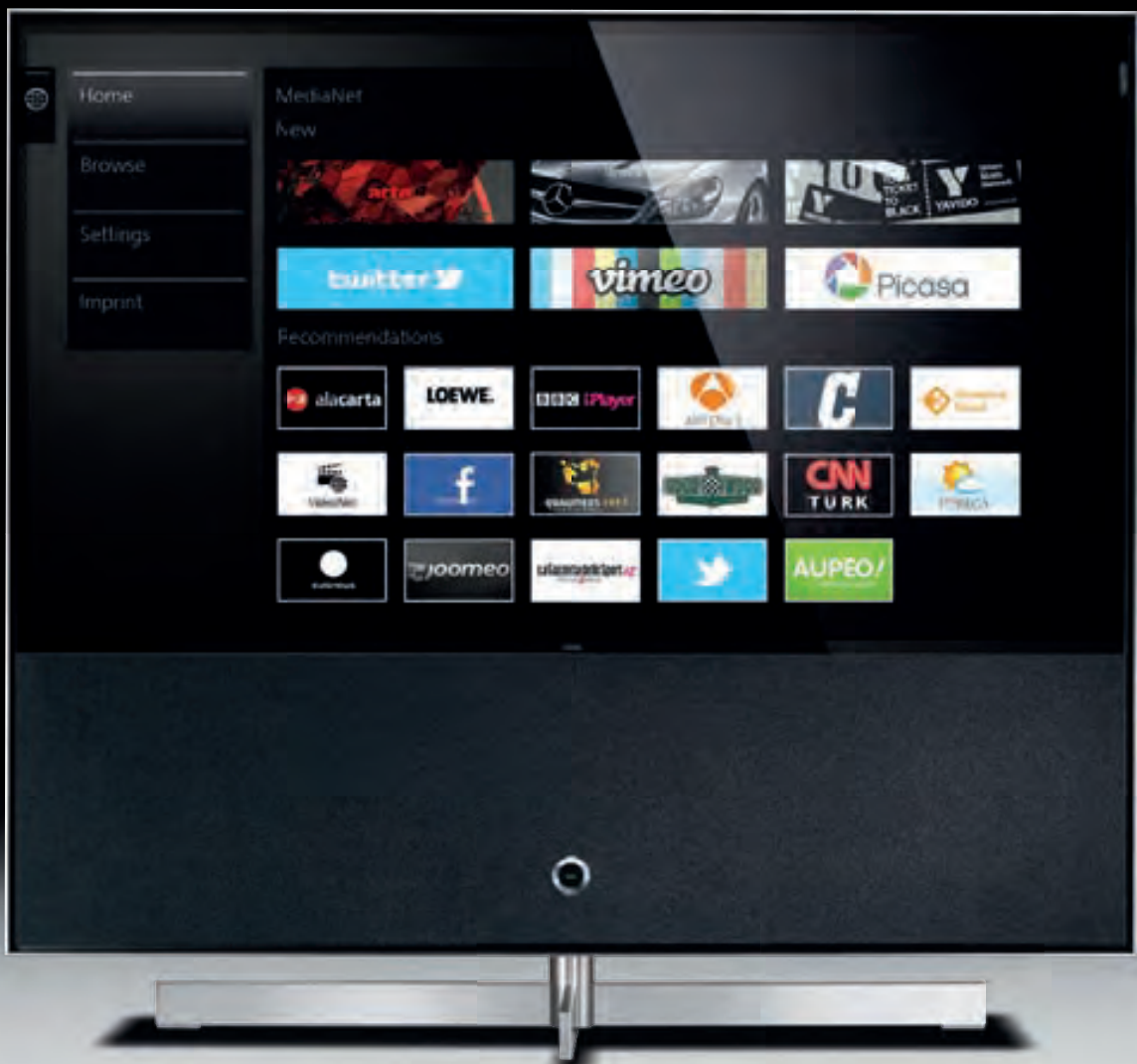

VIP box.

Enjoy your complete home network at a glance.

Loewe MediaHome – Your central point for all digital media.

Easily access all the data carriers and media in your home network – from photos to music, videos from DR+ or other videos (mov, avi, wmv) – via a USB port, network connection (LAN/WLAN/Powerline¹), uPnP/DLNA or HDMI port. You can also use the network connection to access all media files on your computer, subject to your prior authorisation.

The Loewe Assist Media user interface **is arranged** according to the medium you wish to use – regardless of the source. For example, your personal music collection and all available radio stations can be found under “Audio/Radio”.

All your smart home entertainment **connections** from a single source:

- 3x USB ports to connect external hard drives, digital cameras, etc.
- 4x HDMI ports to connect additional entertainment media (for example, Loewe BluTech Vision 3D or Blu-ray player)
- LAN/WLAN for perfect Internet connection
- Mini scart and mini VGA

¹ Powerline available separately from Loewe specialist dealers.



Luxury.

Premium service for your prized asset.

The Loewe Reference ID is a long-term asset. Starting with its timeless design and premium materials. And not forgetting its features and an update option to ensure that your Loewe Reference ID is up to date at all times, for long-lasting enjoyment of luxury smart home entertainment.

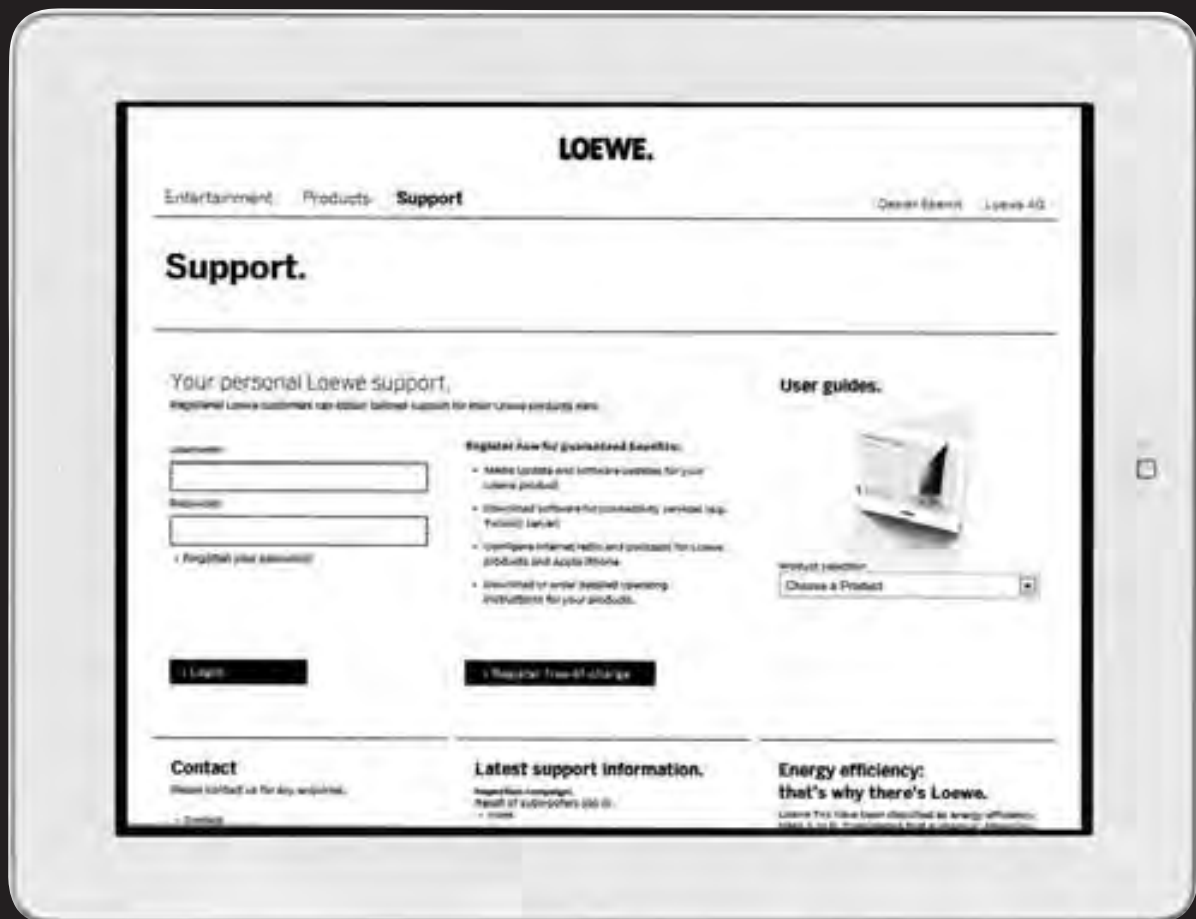



Long-term benefits thanks to exclusive service: We offer extended warranty options for the Loewe Reference ID. Any problems that arise after the warranty has expired can still be resolved, as Loewe's repair service stocks a wide range of components for many years into the future.



Always up to date: The special software concept for the Loewe Reference ID allows you to upgrade various features separately, as and when you please. Loewe uses the Loewe MediaUpdate function to quickly and easily bring you the latest top functions. To receive software upgrades, simply register free of charge in the service area on www.loewe.tv. Or connect your television directly to the Internet to automatically check available software updates for your Loewe Reference ID.

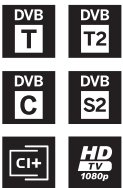

The best picture – and in the future too: No matter how you receive your television signal now or in the future, with the Loewe Reference ID you're perfectly equipped. Integrated receivers for high-definition television (HD-TV) and all digital video broadcasting aerial, satellite and cable standards (DVB-T/S/C) deliver a crystal-clear picture. The Loewe Reference ID is also ready for second-generation standards (DVB-T2/S2).



If you have any questions about your Loewe smart home entertainment, please contact your local service hotline. Our experts will be happy to help. For more information www.loewe.tv. Of course, your local Loewe dealer will also be pleased to advise you. To locate your nearest dealer, use the dealer search feature on our website www.loewe.tv.

Da Capo.

The five top reasons for choosing the new Loewe Reference ID.



The most exclusive design: customised with fine materials and premium frames.



Outstanding sound: integrated 2.1 sound with 160 watts – can be seamlessly expanded with exclusive Reference ID speakers to create a top-class smart home entertainment system.



Revolutionary operating system: Loewe Assist Media with simple cross-based navigation brings all applications together in a single menu interface.



Unique Loewe DR+: easy pausing, streaming and recording to a 1 TB hard drive.



Future-proof: Loewe MediaUpdate for new functions, TV receivers for current and future standards and long-term service benefits.



Loewe Reference ID.
Product details.



360° design

The Loewe Reference ID design concept is easily recognisable from any angle: minimalist design, premium workmanship and fine materials distinguish even the back of the television set. Of course, the customisation options extend to the back of the TV as well. To tailor your Loewe Reference ID precisely to your requirements and wishes – from front to back.



Floor Stand Reference ID 40–55

Aluminium Silver
 With motorised rotation mechanism
 55": W 126.4/H 115.7/PD 7.3/TD 52.7
 46": W 107.0/H 104.7/PD 7.3/TD 52.7
 40": W 93.8/H 97.3/PD 7.3/TD 52.7
 Optional: LED backlighting



Wall Mount Isoflex Reference ID 40–55

Aluminium Silver
 55": W 126.4/H 105.3/PD 7.3/TD 10.5 to 48.0
 46": W 107.0/H 94.3/PD 7.3/TD 10.5 to 48.0
 40": W 93.8/H 86.8/PD 7.3/TD 10.7 to 48.0
 Optional: LED backlighting



Floor Stand Reference ID 40–55 Dynamic

Aluminium Silver
 55": W 126.4/H 105.5/PD 7.3/TD 38.1
 46": W 107.0/H 94.7/PD 7.3/TD 38.1
 40": W 93.8/H 87.3/PD 7.3/TD 38.1
 Optional: LED backlighting



Floor Wall Mount Kit

Aluminium Silver
 55": W 126.4/H 105.5/PD 7.3/TD 24.0
 46": W 107.0/H 94.7/PD 7.3/TD 25.5
 40": W 93.8/H 87.3/PD 7.3/TD 24.1
 Optional: LED backlighting

TV housing
 sizes

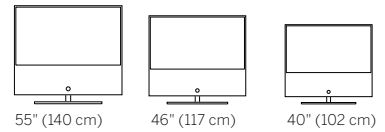

TV frame
 colours

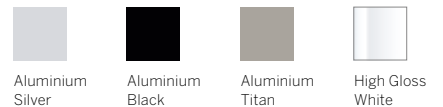

TV speaker cover
 fabrics

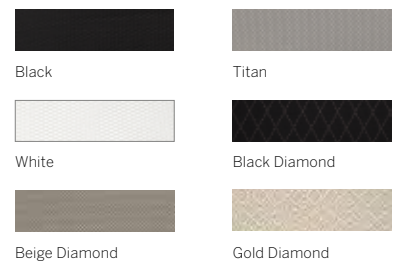

TV rear wall panel
 colours



TV rear wall cover
 colours

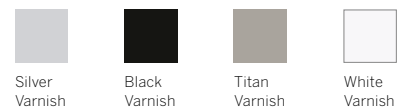

Technological features

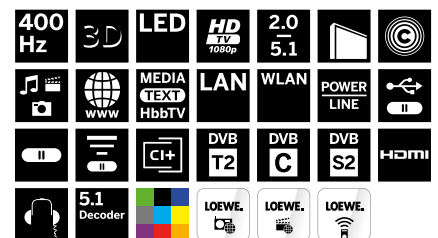

Dimensions in cm: W = Width, H = Height, PD = Product Depth, TD = Total Depth
 Included with delivery: Assist 1 system remote control, aluminium, including batteries.
 Note: In some cases, products are pictured with optional accessories.

System set-up options



Floor Stand Dynamic

To ensure a harmonious result, your choice of set-up solutions extends to the Loewe Reference ID speakers as well as the actual Loewe Reference ID.



Floor stand

The Floor Stand set-up solution conveys presence and distinction.



Wall Mount

The Wall Mount particularly emphasises the harmonious blend of heights between the Loewe Reference ID speakers and Loewe Reference ID 40.

TV speaker



Floor Stand Dynamic

Aluminium Silver
W 20.0 / H 87.0 /
PD 6.4 / TD 35.6

Floor Stand

Aluminium Silver
W 32.0 / H 97.5 /
PD 6.4 / TD 32.0

Wall Mount

W 20.0 / H 86.8 /
PD 6.4 / TD 7.2

Speaker frame

colours



Aluminium
Silver



Aluminium
Black



Aluminium
Titan



High Gloss
White

Speaker cover

fabrics



Black



Titan



White



Black
Diamond



Beige
Diamond



Gold
Diamond

Speaker rear wall

colours



Matt Silver



Matt Black



Matt Titan





Matt White

Loewe Reference ID.
Technical information.

55
including DR+ 

46
including DR+ 

Image+ (picture)	55 including DR+ 	46 including DR+ 
Contrast filter panel / High gloss frame	● / —	● / —
Display technology	Full HD-LCD with E-LED backlight	Full HD-LCD with E-LED backlight
Screen diagonal (in cm / inch) / Picture format / Resolution (in pixels)	140 / 55 / 169 / 1,920 / 1,080	117 / 46 / 169 / 1,920 / 1,080
Brightness (in cd / m ²) / Viewing angle (horizontal / vertical)	450 / 178° / 178°	450 / 178° / 178°
Contrast (static / dynamic)	5,000 : 1 / 5,000,000 / 1	5,000 : 1 / 5,000,000 / 1
Response time (in ms) / Picture repetition rate	5 / 400Hz	5 / 400Hz
Fully digitised signal processing / Image+ Active / 24p motion picture display	● / ● / ●	● / ● / ●
3D technology / 2D-3D conversion / Active Glasses 3D	● / ● / ○	● / ● / ○
Format options ¹ (16: 9, 4 : 3, Panorama, Zoom)	●	●
Video auto-dimming (VBD+) / Interior auto-dimming (OPC) / Home Mode	● / ● / ●	● / ● / ●
Sound+ (tone)		
Output in watts (music / sine)	2 x 20 + 40 / 2 x 40 + 80	2 x 20 + 40 / 2 x 40 + 80
Acoustic speaker concept	PRX 2.1 sound system	PRX 2.1 sound system
Individual bass and treble control / Volume / Sound effects	● / ● / ●	● / ● / ●
Automatic voice detection / Automatic Volume Control (AVC)	● / ●	● / ●
Dolby Digital Plus / dts / 5.1 Out / Two channel	● / ● / ● / ●	● / ● / ● / ●
Audio out available: variable / fixed / subwoofer	● / ● / ● (via Digital Audio Link)	● / ● / ● (via Digital Audio Link)
Digital+ (television standards)		
DVB-T / DVB-T2 / DVB-C / DVB-S2 / multistandard (analogue) / Dual Channel	● / ● / ● / ● / ● / ●	● / ● / ● / ● / ● / ●
A / V decoding: MPEG / MPEG2 / MPEG4 / integrated HDTV reception ²	● / ● / ● / ●	● / ● / ● / ●
Colour standard: PAL / Secam / NTSC / NTSC-V / PAL-V (60 Hz)	● / ● / ● / ● / ●	● / ● / ● / ● / ●
Audio standard: two channel FM / AM, Nicam	● / ●	● / ●
Assist+ (Operation)		
Automatic Channel Programming (ACP) / Channel recognition	● / ●	● / ●
DVB radio / Programme positions including AV and radio	● / 6,000	● / 6,000
Digital Link Plus / Digital Link HD	● / ●	● / ●
Video text Level 2.5 / TOP video text / FLOF video text / Page memory	● / ● / ● / 2,000	● / ● / ● / 2,000
Personalised video text with direct access to Favourites / bookmarked pages	● / ●	● / ●
PIP (AV) ³ / Full PIP ⁴ / Splitscreen TV: Video text Video text	● / ● / ●	● / ● / ●
Electronic Programme Guide (EPG) / Assist Media app	● / ●	● / ●
Parental Lock / Automatic turn-off / Timer	● / ● / ●	● / ● / ●
Electronic instruction manual / Menu languages ⁵	● / 19	● / 19
Index / Context-related help	● / ●	● / ●
Media+ (Multimedia functions)		
DR+ / Storage capacity in GB / USB recording (for DR+: USB archive)	● / 1,000 / ●	● / 1,000 / ●
DR+ streaming server / client	● / ●	● / ●
MediaHome (photos, music and video via home network / USB)	● / ●	● / ●
MediaNet (Internet portal / Browser / Internet radio)	● / ● / ●	● / ● / ●
MediaText (HbbTV) / MediaUpdate	● / ●	● / ●
Connectivity+ (Connectors)		
HDMI with HDCP / USB / Component (YUV) In ⁶	4 (1 x ARC) / 3 / ○	4 (1 x ARC) / 3 / ○
Mini scart / S-VHS, Hi-8 / RGB	1 / 1 / 1	1 / 1 / 1
Copy function Front-AV to Euro-AV	●	●
Digital audio-in (cinch) / Digital audio-out (cinch)	● / ●	● / ●
Analogue audio-out (L / R) / Centre-in (cinch)	● / ●	● / ●
Analogue Audio Link ⁷ / Digital Audio Link ⁷	— / ●	— / ●
VGA / RS 232 C (RJ12) / Motor control / IR-Link	Mini-VGA / ● / ● / ●	Mini-VGA / ● / ● / ●
Side AV Video- / S-VHS, Hi-8-ready / Headphone (jack 3.5 mm)	● / ● / ●	● / ● / ●
Common Interface CI / CI Plus certified ⁸	2 / ●	2 / ●
LAN network connection / integrated WLAN	● / ●	● / ●
Environment		
EU energy efficiency class / Annual energy consumption (kWh) ⁹	A / 166	B / 151
Power consumption in stand-by mode / when set turned off (in watts)	0.47 / 0	0.47 / 0
Power consumption "ON" ¹⁰ (in watts) / Peak luminance ratio in %	120 / 65	109 / 73
Mercury content in mg / contains lead ¹¹	0.0 / traces	0.0 / traces
Accessories		
LED backlighting	□	□
Miscellaneous		
Weight (approx.) in kg	45.5	36.5
Power switch / Mains voltage	● / 220–240 V, 50/60 Hz	● / 220–240 V, 50/60 Hz
VDE safety standard (inspection seal)	●	●

● = included/installed ○ = upgradeable/optional □ = variant ex works

¹ Dependent on SD/HD input format.

² Reception of digital channels may be limited by individual regulations from the respective broadcaster/provider.

³ On sets without DR+, AV-PIP is only available in combination with DVB-T/C/S.

⁴ Not with MPEG4.

⁵ D-GB-F-I-E-NL-CZ-GR-PL-H-FIN-SLO-SK-TR-S-DK-P-RUS-N

⁶ Only in conjunction with a corresponding adaptor, to be ordered separately.

⁷ Loewe system 5.1 out, stereo out, subwoofer out, centre in.

⁸ CI Plus is backwards compatible with CI

Functionality is dependent on module availability from the supplier.

40
including DR+ **HD**
1080p

● / —
Full HD-LCD with E-LED backlight
102/40/169/1,920/1,080
450/178°/178°
5,000:1/5,000,000/1
5/400Hz
● / ● / ●
● / ● / ○
●
● / ● / ●

2 x 20 + 40 / 2 x 40 + 80
PRX 2.1 sound system
● / ● / ●
● / ●
● / ● / ● / ●
● / ● / ● (via Digital Audio Link)

● / ● / ● / ● / ● / ●
● / ● / ● / ●
● / ● / ● / ● / ●
● / ●

● / ●
● / 6,000
● / ●
● / ● / ● / 2,000
● / ●
● / ● / ●
● / ●
● / ● / ●
● / 19
● / ●

● / 1,000 / ●
● / ●
● / ●
● / ● / ●
● / ●

4 (1 x ARC) / 3 / ○
1 / 1 / 1
●
● / ●
● / ●
— / ●
Mini-VGA / ● / ● / ●
● / ● / ●
2 / ●
● / ●

B/133
0.47/0
96/66
0.0/traces

□

30.5
● / 220–240 V, 50/60 Hz
●

Loewe Reference ID speaker.

Technical information.

General	
Principle	3-way bass reflex (d'Appolito configuration)
Nominal power handling / music power handling (sine/max.)	50 W / 80 W
Recommended amplification output	10 W – 150 W
Frequency range	80 Hz – 30 kHz (the ceramic full-range speakers are capable of playing back up to 40kHz – the loudspeaker grille reduces the playback frequency to 30kHz).
Impedance	4 – 18 ohm
Volume	4 litres
Features	
Speaker complement	2 x 155 mm bass speakers 2 x 155 mm passive membrane 2 x 60 mm ceramic broadband speakers
Speaker connections	Screw terminals, gold-plated
Accessories	
Speaker cable	2 x 6 m, 1.5 mm ²
Wall Mount	●
Miscellaneous	
Weight (approx.) in kg	4.4

Loewe Subwoofer 800.

Technical information.

General	
Principle	Active subwoofer, passive radiator
Nominal / music power (sine/max.)	300 watts / 600 watts (subwoofer channel)
Frequency range	28 Hz – 250 Hz
Features	
digital amplifiers	Total power: 800 watts 5 digital power amps (Class D) to connect front and surround speakers: each 100 watts (sine), 4 ohm; 1 digital power amp (Class D) for subwoofer channel: 300 watts (sine)
Bass control	● -12 dB / +12 dB
Phase switch	●
Low pass filter	50 Hz – 250 Hz
Bass equaliser	●
Power switch	●
Stand-by switch	●
Signal recognition	—
Audio Link	●
Speaker complement	1 bass speaker 2 passive radiators
Connections	Screw terminals, gold-plated
Cinch connections	gold-plated
Accessories	
Audio Link cable	●
Electronics cover	●
Loudspeaker grille	●
Module Wireless Audio Link	—
Miscellaneous	
Weight (approx.) in kg	24.0

⁹ On the basis of four hours of operation per day, 365 days a year. Actual energy consumption depends on the purpose for which the TV is used.

¹⁰ To EN 62087:2009, 2009

¹¹ Occasionally, traces may be found in electronic components (in compliance with European RoHS directive).

Loewe Opta GmbH
Industriestraße 11
96317 Kronach
Germany
www.loewe.tv

Loewe UK Ltd
237A Kensington High St
1st Floor
London W8 6SA
United Kingdom
www.loewe.tv

Technical modifications, delivery conditions and errors excepted · Item no. 99 005 730 · Editorial deadline 29 April 2013 · Printed in Germany.

Due to different printing processes, the colours depicted in device illustrations may be subject to variation. Some of the colours/materials featured in the brochure are special productions from the customisation selections. These are produced to order and in some cases longer delivery times may apply. All Loewe products featured in the catalogue are intended for private use.

Loewe makes no guarantee for the extent and content of the Internet services that can be received. This also applies to the Loewe MediaNet portal. By supplying its appliances, Loewe provides the technical platform that creates a basic capability to receive these offers. Loewe cannot therefore provide any guarantee in relation to changes in scope and content, in particular with respect to the future and after printing.

iPad, iPhone, iPod are trademarks of Apple Inc., registered in the U.S. and other countries.

LOEWE.